

Operating and Service Manual

FL7040

Model

10027317

Part Number

Serial Number



Declaration of Conformity

Issue Date: December 2018
Model #/s: FL7030/Kit, FL7006/Kit, FL7218/Kit, FL7040/Kit, FL7060/Kit, PL7004/Kit, FI7000, FL7030, FL7006, FL7218, FL7040, FL7060, & PL7004
Type of Equipment: RF/Microwave Electric Field Probe
Function: Designed to be used in a RF immunity test system or for research. These devices are intended to measure RF electric fields.

The equipment described above is declared to be in conformity with the following applicable national and international standards. The conformity is valid only when equipment is used in a manner consistent with the manufacturer’s recommendations and the reference documents.

EMC:
DIRECTIVE 2014/30/EU OF THE EUROPEAN PARLIAMENT AND OF THE COUNCIL of 26 February 2014 on the harmonisation of the laws of the Member States relating to electromagnetic compatibility
EN 61326-1:2013 Electrical equipment for measurement, control and laboratory use–EMC requirements–Part 1: General Requirements
SAFETY:
DIRECTIVE 2014/35/EU OF THE EUROPEAN PARLIAMENT AND OF THE COUNCIL of 26 February 2014 on the harmonisation of the laws of the Member States relating to the making available on the market of electrical equipment designed for use within certain voltage limits
CENELEC EN 61010-1 Issued 2010/10/01 Ed: 3 Safety Requirements for Electrical Equipment for Measurement Control and Laboratory Use – Part 1: General Requirements
UL 61010-1 Issued 2012/05/11 Ed: 3 Safety Requirements for Electrical Equipment for Measurement Control and Laboratory Use – Part 1: General Requirements
CAN/CSA C22.2 #61010-1 Issued 2012/05/11 Ed: 3 Safety Requirements for Electrical Equipment for Measurement Control and Laboratory Use – Part 1: General Requirements
HAZARDOUS SUBSTANCES (RoHS 3):
DIRECTIVE (EU) 2017/2105 OF THE EUROPEAN PARLIAMENT AND OF THE COUNCIL of 15 November 2017 on the restriction of the use of certain hazardous substances in electrical and electronic equipment (recast)
RECYCLING (WEEE):
DIRECTIVE 2012/19/EU OF THE EUROPEAN PARLIAMENT AND OF THE COUNCIL of 4 July 2012 on waste electrical and electronic equipment (WEEE) (recast)
SUBSTANCES OF VERY HIGH CONCERN (REACH):
REGULATION (EC) 1907/2006 OF THE EUROPEAN PARLIAMENT AND OF THE COUNCIL of 18 December 2006 concerning the Registration, Evaluation, Authorization and Restriction of Substances of Very High Concern Chemicals (SVHC)

Supporting documentation is held by AR RF/Microwave Instrumentation’s Quality department in Pennsylvania, United States.

Place of issue: AR RF/Microwave Instrumentation
160 School House Road
Souderton, Pennsylvania 18964 USA

Authorized officer of the company:

Patricia Thrasher
Manager Quality, Customer Service, Purchasing



**Complies with 21CFR 1040.10 and 1040.11
except for deviations pursuant
to Laser Notice # 50,
dated June 24, 2007**

**MANUFACTURED BY:
AR RF/Microwave Instrumentation
160 School House Rd
Souderton, PA 18964**

DATE OF MANUFACTURE:

--	--

Month Year

INSTRUCTIONS FOR SAFE OPERATION









Observe the following safety guidelines to help ensure your own personal safety and to help protect your equipment and working environment from potential damage.

INTENDED USE

This equipment is intended for general laboratory use in generating, controlling, and measuring levels of electromagnetic Radio Frequency (RF) energy. Ensure that the device is operated in a location which will control the radiated energy and will not cause injury or violate regulatory levels of electromagnetic interference.

SAFETY SYMBOLS

These symbols may appear in your user manual or on equipment.

	This symbol is marked on the equipment when it is necessary for the user to refer to the manual for important safety information. The caution symbol denotes a potential hazard. Attention must be given to the statement to prevent damage, destruction, or harm.
	Dangerous voltages are present. Use extreme care.
	Indicates a terminal intended for connection to an external conductor for protection against electrical shock in case of a fault, or the terminal of a protective earth (ground) electrode.
	Indicates invisible laser radiation—do not view directly with optical instruments.
	Indicates frame or chassis ground connection terminal.
	Indicates alternating current.
	Indicates this product must not be disposed of with your other household waste.
	Indicates that the marked surface and adjacent surfaces can attain temperatures that may be hot to the touch.

EQUIPMENT SETUP PRECAUTIONS



Review the user manual and become familiar with all safety markings and instructions. Protection provided by the equipment may be impaired if used in a manner not specified by AR RF/Microwave Instrumentation (AR).

- Follow all lifting instructions specified in this document.
- Place the equipment on a hard, level surface.
- Do not use the equipment in a wet environment, for example, near a sink, or in a wet basement.
- Position your equipment so that the power switch is easily accessible.
- Leave 10.2 cm (4 in) minimum of clearance on all vented sides of the equipment to permit the airflow required for proper ventilation. Do not restrict airflow into the equipment by blocking

any vents or air intakes. Restricting airflow can result in damage to the equipment, intermittent shut-downs or safety hazards.

- Keep equipment away from extremely hot or cold temperatures to ensure that it is used within the specified operating range.
- While installing accessories such as antennas, directional couplers and field probes, take care to avoid any exposure to hazardous RF levels.
- Ensure that nothing rests on your equipment's cables and that the cables are not located where they can be stepped on or tripped over.
- Move equipment with care; ensure that all casters and/or cables are firmly connected to the system. Avoid sudden stops and uneven surfaces.

BEFORE APPLYING POWER

Your AR equipment may have more than one power supply cable. Use only approved power cable(s). If you have not been provided with a power cable for the equipment or for any AC-powered option intended for the equipment, purchase a power cable that is approved for use in your country. The power cable must be rated for the equipment and for the voltage and current marked on the equipment's electrical ratings label.



Incorrectly installing or using an incompatible line voltage may increase the risk of fire or other hazards. To help prevent electric shock, plug the equipment and peripheral power cables into properly grounded electrical outlets. These cables are equipped with three-prong plugs to help ensure proper grounding. Do not use adapter plugs or remove the grounding prong from a cable.

Do not modify power cables or plugs. Consult a licensed electrician or AR trained service technician for equipment modifications. Always follow your local/national wiring rules.



Do not operate the equipment if there is physical damage, missing hardware, or missing panels.

SAFETY GROUND



This equipment is provided with a protective earth terminal. The mains power source to the equipment must supply an uninterrupted safety ground of sufficient size to attach wiring terminals, power cord, or supplied power cord set. ***DO NOT USE this equipment if this protection is impaired.***

INSTRUCTIONS FOR SAFE OPERATION

HAZARDOUS RF VOLTAGES

The RF voltages on the center pin of an RF output connector can be hazardous. The RF output connector should be connected to a load before AC power is applied to the equipment. Do not come into contact with the center pin of the RF output connector or accessories connected to it. Place the equipment in a non-operating condition before disconnecting or connecting the load to the RF output connector.



ACOUSTIC LIMITATIONS

If equipment noise exceeds 80dB, ear protection is required.

MAINTENANCE CAUTION

Adjustment, maintenance, or repair of the equipment must be performed only by qualified personnel. Hazardous energy may be present while protective covers are removed from the equipment even if disconnected from the power source. Contact may result in personal injury. Replacement fuses are required to be of specific type and current rating.

ENVIRONMENTAL CONDITIONS

Unless otherwise stated on the product specification sheet, this equipment is designed to be safe under the following environmental conditions:

- Indoor use
- Altitude up to 2000m
- Temperature of 5°C to 40°C
- Maximum relative humidity 80% for temperatures up to 31°C. Decreasing linearly to 50% at 40°C.
- Main supply voltage fluctuations not to exceed $\pm 10\%$ of the nominal voltage or minimum and maximum autoranging values.
- Pollution degree 2: Normally non-conductive with occasional condensation. While the equipment will not cause hazardous condition over this environmental range, its performance may vary.

EQUIPMENT CONTAINING LASERS

 AR Field Probes (FL/PL Series) and Field Analyzers (FA Series) are Class 1 laser products containing embedded Class 4 lasers. Under normal use, the laser radiation is completely contained within the fiber optic cables and poses no threat of exposure. Safety interlocks ensure that the laser is not activated unless the cables are properly connected. Always exercise caution when using or maintaining laser products. Do not view directly with optical instruments.

RF ANTENNAS

- This equipment (antenna or antenna assembly) may be heavy, requiring two persons to lift. Use caution when installing or removing unit. Follow all equipment setup and lifting instructions specified in this document.
- Ensure connectors are appropriate for intended operation. Connectors are specified in the user manual and product specification sheet.
- Do not exceed the maximum RF input level stated in the specifications. Refer to the user manual and product specification sheet to determine the applicable RF levels.
- Excessive RF input could damage the equipment or connectors, causing safety hazards.
- When in operation, the RF voltages on the antenna elements can be hazardous. Do not come into contact with the antenna or elements when the RF input connector is connected to a live RF source.
- To avoid injury to personnel and accidental damage to power amplifier or antenna, disable the RF output of power amplifier before connecting or disconnecting the input connection to the antenna.
- Perform periodic inspections of antenna and field probe systems to verify calibration due date, proper operation, and overall condition of equipment.

RACK MOUNTED TWT MODELS

Some TWT models are supplied without the removable enclosure offered for benchtop use. These rack-mountable models may be supplied with either carry handles or slides and front handles installed. Follow all lifting instructions specified in this document and installation instructions supplied in the TWT user manual.

LIFTING INSTRUCTIONS FOR AR EQUIPMENT

Because most products must be handled during distribution, assembly and use, the risk of serious injury due to unsafe product handling should be a fundamental consideration of every user. An authoritative guideline for eliminating unwarranted risk of injury caused by lifting is provided by the NIOSH Work Practices (Publication #94-110) available at:



<https://www.cdc.gov/niosh/docs/94-110/pdfs/94-110.pdf>.

In general, observe the following guidelines for lifting a weight of 50 lb or more:

- Use lifting eye (for floor standing) or side handles (table top) to lift unit only.
- Use equipment of adequate capacity to lift and support unit.
- If using forklift to move unit, be sure forks are long enough to extend beyond the side of the unit.
- For additional information, follow the link specified above.

HINWEISE FÜR DEN SICHEREN GEBRAUCH









Bitte beachten Sie die folgenden Hinweise zum Schutz Ihrer persönlichen Sicherheit und um Ihre Ausrüstung und Ihren Arbeitsplatz vor möglichen Schäden zu bewahren.

VORGESEHENE VERWENDUNG

Dieses Gerät ist für den allgemeinen Einsatz im Labor bestimmt. Es dient der Erzeugung, Steuerung und Messung von elektromagnetischer Hochfrequenzenergie (RF). Stellen Sie sicher, dass das Gerät an einem Ort in Betrieb genommen wird, an dem die abgestrahlte Energie gesteuert werden kann, so dass niemand Schaden erfährt und elektromagnetische Störungen vermieden werden.

SICHERHEITSSYMBOL

Einige dieser Symbole befinden sich sowohl in der Bedienungsanleitung als auch auf dem Gerät selbst.

	Dieses Symbol befindet sich auf dem Gerät und weist darauf hin, dass der Nutzer an dieser Stelle wichtige Sicherheitsinformationen in der Bedienungsanleitung studieren soll. Das Warnsymbol weist auf eine mögliche Gefahr hin. Zur Vermeidung von Personen- oder Sachschäden gilt es, die Hinweise zu beachten.
	Gefährliche elektrische Spannungen sind vorhanden. Höchste Vorsicht ist geboten.
	Weist darauf hin, dass an dieser Stelle eine Klemme für den Anschluss an einen Außenleiter anzubringen ist, zum Schutz vor einem Stromschlag oder im Fall einer auftretenden Störung, oder dass eine Klemme anzubringen ist, die als schützende Erdungselektrode fungiert.
	Zeigt unsichtbare Laserstrahlung an – nicht direkt hineinschauen.
	Weist auf eine Rahmen- oder Chassis-Anschlussklemme hin.
	Zeigt Wechselstrom an.
	Weist darauf hin, dass dieses Produkt nicht mit Ihrem restlichen Hausmüll entsorgt werden darf.
	Weist darauf hin, dass die markierte Oberfläche und benachbarte Flächen extrem heiße Temperaturen erreichen können und daher nicht angefasst werden sollten.

SICHERHEITSHINWEISE FÜR DEN AUFBAU DES GERÄTS



Lesen Sie die Bedienungsanleitung aufmerksam durch und machen Sie sich mit allen Sicherheitsmarkierungen und Anweisungen vertraut. Die Sicherheit kann beeinträchtigt sein, falls das Gerät in einer anderen Weise verwendet wird, als von der AR RF/Microwave Instrumentation (AR) vorgegeben ist.

- Zum Heben und Transport folgen Sie allen in dieser Anleitung angegebenen Anweisungen.
- Platzieren Sie das Gerät auf einer harten, ebenen Oberfläche.
- Verwenden Sie das Gerät nicht in feuchter Umgebung, zum Beispiel in der Nähe einer Spüle oder in einem feuchten Keller.
- Platzieren Sie Ihr Gerät so, dass der Netzschalter leicht zugänglich ist.

- Halten Sie einen Mindestabstand von 10,2 cm (4 in) auf allen belüfteten Seiten des Geräts ein, um eine ausreichende Luftzirkulation zu gewährleisten. Beeinträchtigen Sie den Luftstrom des Geräts nicht, indem Sie Lüftungsöffnungen oder den Lufteinlass blockieren. Wird der Luftstrom eingeschränkt, kann dies zu Schäden am Gerät, periodischen Abschaltungen und anderen Gefahren führen.
- Halten Sie das Gerät von extrem heißen oder kalten Temperaturen fern, um sicherzustellen, dass es nur in dem vorgeschriebenen Bedienungsbereich verwendet wird.
- Achten Sie beim Installieren von Zubehör wie Antennen, Richtungskupplungen und Feldsonden darauf, dass sie keinen gefährlichen HF-Werten ausgesetzt sind.
- Stellen Sie sicher, dass nichts auf den Kabeln Ihres Geräts steht. Bringen Sie die Kabel so an, dass niemand darauf treten oder darüber stolpern kann.
- Seien Sie vorsichtig, wenn Sie das Gerät bewegen. Achten Sie darauf, dass alle Rollen und/oder Kabel fest mit dem System verbunden sind. Vermeiden Sie plötzliche Stopps und Oberflächen, die nicht eben sind.

BEVOR SIE DAS GERÄT ANSCHLIESSEN

Ihre AR-Ausrüstung hat möglicherweise mehr als ein Stromversorgungskabel. Verwenden Sie nur zugelassene Stromkabel. Falls Sie kein Stromkabel oder AC-Netzkabel für dieses Gerät haben, kaufen Sie ein Stromkabel, das für den Einsatz in Ihrem Land zugelassen ist. Das Stromkabel muss für das Gerät, die Spannung und den Strom, die auf dem elektrischen Kennzeichnungsetikett des Geräts markiert sind, zugelassen sein.



Bei einer fehlerhaften Installation oder falls eine Netzspannung verwendet wird, die nicht mit dem Gerät kompatibel ist, erhöht sich die Brandgefahr. Auch andere Gefahren können auftreten. Um einen Stromschlag zu verhindern, schließen Sie das Gerät und die peripheren Stromkabel an ordnungsgemäß geerdete Steckdosen an. Die Kabel sind mit dreipoligen Steckern ausgestattet, um eine korrekte Erdung zu gewährleisten. Verwenden Sie keine Adapter. Entfernen Sie niemals die Erdungsstange eines Kabels.

Modifizieren Sie niemals die Stromkabel oder Stecker. Konsultieren Sie einen lizenzierten Elektriker oder AR-ausgebildeten Servicetechniker, falls Veränderungen am Gerät durchgeführt werden müssen. Halten Sie sich stets an die nationalen/örtlichen Verdrahtungsregeln.



Schalten Sie das Gerät nicht ein, falls es äußerlich beschädigt ist oder Hardware-Teile oder Konsolen fehlen.

SYSTEMERDUNG



Dieses Gerät ist mit einer Schutzerdklemme ausgestattet. Die Netzstromquelle muss dem Gerät eine ununterbrochene Systemerdung von ausreichender Größe zur Verfügung stellen, damit Kabelklemmen, Netzkabel oder mitgeliefertes Netzkabel ordentlich befestigt werden können. **VERWENDEN SIE DIESES GERÄT NICHT, wenn dieser Schutz beeinträchtigt ist.**

HINWEISE FÜR DEN SICHEREN GEBRAUCH

GEFÄHRLICHE HF-SPANNUNGEN



Die HF-Spannungen am mittleren Pin eines HF-Ausgangsanschlusses können gefährlich sein. Der HF-Ausgangsanschluss sollte an eine Last angeschlossen werden, bevor das Gerät ans Stromnetz angeschlossen wird. Kommen Sie nicht mit dem Mittelstift des HF-Ausgangsanschlusses oder dem damit verbundenen Zubehör in Kontakt. Bevor Sie die Last vom HF-Ausgang trennen oder diese anschließen, stellen Sie das Gerät in einen nicht betriebsfähigen Zustand.

HÖRSCHUTZ

Sollten die Geräusche, die das Gerät verursacht, 80dB überschreiten, ist Gehörschutz erforderlich.

WARTUNGSHINWEISE

Einstellung, Wartung oder Reparaturen der Ausrüstung dürfen nur von qualifizierten Fachleuten durchgeführt werden. Gefährliche Spannungen können auftreten, wenn Schutzabdeckungen vom Gerät entfernt werden, auch wenn es nicht an die Stromquelle angeschlossen ist. Kontakt kann zu Verletzungen führen. Es können nur bestimmte Ersatzsicherungen mit speziellem Nennstrom verwendet werden.

UMGEBUNGSBEDINGUNGEN

Sofern auf dem Produktspezifikations-Blatt nichts anderes angegeben ist, ist dieses Gerät unter folgenden Bedingungen sicher einsetzbar:

- Gebrauch in Innenräumen
- Höhe bis zu 2000m
- Temperaturen von 5°C bis 40°C
- Maximale relative Luftfeuchtigkeit 80% bei Temperaturen bis 31°C. Lineare Abnahme auf 50% bei 40°C.
- Netzspannungsschwankungen sollen nicht mehr als $\pm 10\%$ der Nennspannung oder der minimal und maximal eingestellten Werte betragen.
- Verschmutzungsgrad 2: Normalerweise nichtleitfähige Verschmutzung mit gelegentlicher Kondensation. Das Gerät wird bei Einsatz in diesem Bereich keine Gefahr verursachen, die Leistung kann dennoch variieren.

LASER-INFORMATION



AR - Feldsonden (FL/PL-Serie) und Feldanalysatoren (FA-Serie) sind Laserprodukte der Klasse 1 mit eingebetteten Klasse-4-Lasern. Bei normalem Gebrauch kann der Laserstrahlung nicht aus den Glasfaserkabel herausdringen. Sicherheitsverriegelungen sorgen dafür, dass der Laser nur aktiviert wird, wenn die Kabel richtig angeschlossen sind. Lassen Sie stets Vorsicht walten bei der Verwendung oder Wartung von Laserprodukten. Niemals direkt hineinschauen.

HF-ANTENNEN

- Die Ausrüstung (Antenne oder Antennenmontage) ist mitunter schwer. Die Montage erfordert daher oft zwei Personen. Folgen Sie allen in diesem Dokument angegebenen Anweisungen zur Anbringung.
- Stellen Sie sicher, dass alle Anschlüsse für den beabsichtigten Betrieb geeignet sind. Informationen zu den Anschlüssen erhalten Sie im Benutzerhandbuch und im Produktspezifikationsblatt.
- Überschreiten Sie nicht den in Spezifikationen angegebenen maximalen HF-Eingangspegel. Informationen zum geeigneten HF-Pegel erhalten Sie im Benutzerhandbuch und im Produktspezifikationsblatt.
- Ein übermäßiger HF-Eingang könnte das Gerät oder die Anschlüsse beschädigen, was zu Sicherheitsrisiken führt.
- Im Betrieb können die HF-Spannungen an den Antennenelementen gefährlich sein. Kommen Sie nicht mit der Antenne oder Antennenelementen in Kontakt, wenn der HF-Eingang an eine live-HF-Quelle angeschlossen ist.
- Um Verletzungen an Personen, am Leistungsverstärker oder der Antenne zu vermeiden, deaktivieren Sie den HF-Ausgang des Leistungsverstärkers, bevor sie die Eingangsverbindung an die Antenne anschließen oder trennen.
- Kontrollieren Sie die Antennen und die Feldsonde regelmäßig, um die nächstfällige Kalibrierung, den ordnungsgemäßen Betrieb und den Gesamtzustand der Ausrüstung zu überprüfen.

RACK MONTIERBARE TWT-MODELLE

Einige TWT-Modelle kommen ohne die abnehmbare Überdachung, die zur Verwendung als Tischgerät dient. Diese rack-montierbaren Modelle verfügen entweder über installierte Tragegriffe oder Rutschflächen. Befolgen Sie alle in diesem Dokument angegebenen Hebehinweise sowie die Installationsanweisungen in der TWT-Bedienungsanleitung.

HEBEANWEISUNGEN FÜR AR-GERÄTE

Die meisten Geräte müssen während des Versands, der Montage und des Gebrauchs transportiert werden. Jeder Nutzer sollte sich über das Risiko von schweren Verletzungen durch unsachgemäße Produkthandhabung bewusst sein. Leitlinien zur Beseitigung von vermeidbaren Verletzungsrisikos, die beim Heben entstehen können, werden in den NIOSH-Arbeitspraktiken (Veröffentlichung # 94-110) zur Verfügung gestellt:



<https://www.cdc.gov/niosh/docs/94-110/pdfs/94-110.pdf>.

Beachten folgende, allgemeine Richtlinien zum Heben eines Gewichts von 50 Pfund oder mehr:

- Verwenden Sie zum Heben der Einheit eine Hebeöse (für Platzierung auf dem Boden) oder Seitengriffe (für Platzierung auf einer Arbeitsplatte).
- Verwenden Sie Geräte mit ausreichender Kapazität zum Heben und Stützen.
- Falls Sie einen Gabelstapler verwenden, achten Sie darauf, dass die Gabeln lange genug sind und über die Seiten der Einheit hinausreichen.
- Für weitere Informationen folgen Sie dem oben angegebenen Link.

INSTRUCTIONS POUR UN FONCTIONNEMENT EN TOUTE SÉCURITÉ









Respectez les consignes de sécurité suivantes pour veiller à votre propre sécurité et vous aider à protéger votre équipement et votre milieu de travail de dommages potentiels.

USAGE PRÉVU

Cet équipement est prévu pour un usage général en laboratoire afin de générer, contrôler et mesurer les niveaux d'énergie de radiofréquence (RF) électromagnétique. Assurez-vous que l'appareil est utilisé dans un endroit qui contrôlera l'énergie rayonnante et ne causera pas de blessure, ni ne violera les niveaux réglementaires d'interférence électromagnétique.

SYMBOLES DE SÉCURITÉ

Ces symboles peuvent apparaître dans votre manuel d'utilisation ou sur l'équipement.

	Ce symbole est apposé sur l'équipement lorsque l'utilisateur doit se référer au manuel pour des informations importantes concernant la sécurité. Le symbole de mise en garde indique un danger potentiel. Vous devez accorder une attention à la déclaration pour éviter tout dommage, destruction ou blessure.
	Présence de tensions dangereuses, soyez très prudent.
	Indique une borne de connexion d'un conducteur externe pour une protection contre l'électrocution en cas de défaillance ou la borne d'une électrode de mise à la terre de protection.
	Indique un rayonnement laser invisible – ne regardez pas directement avec des instruments optiques.
	Indique la borne de connexion de la mise à la terre du cadre ou du châssis.
	Indique un courant alternatif.
	Indique que ce produit ne doit pas être jeté avec vos autres déchets ménagers.
	Indique que la surface marquée et les surfaces adjacentes peuvent atteindre des températures qui risquent d'être chaudes au toucher.

PRÉCAUTIONS D'INSTALLATION DE L'ÉQUIPEMENT

 Lisez le manuel d'utilisateur et familiarisez-vous avec tous les marquages et consignes de sécurité. La protection fournie par l'équipement peut être affaiblie s'il est utilisé d'une manière non indiquée par AR RF/instrumentation à hyperfréquence (AR).

- Respectez toutes les instructions de levage indiquées dans ce document.
- Placez l'équipement sur une surface dure et plane.

- N'utilisez pas l'équipement dans un environnement humide, par exemple près d'un lavabo, ou dans un sous-sol humide.
- Positionnez votre équipement de sorte que l'interrupteur d'alimentation soit facilement accessible.
- Laissez un espace minimal de 10,2 cm (4 in) de tous les côtés ventilés de l'équipement pour permettre le flux d'air nécessaire à une bonne ventilation. Ne limitez pas le flux d'air allant dans l'équipement en bloquant tout évent ou entrée d'air. La restriction du flux d'air peut endommager l'équipement, causer des coupures intermittentes ou des dangers pour la sécurité.
- Tenez l'équipement à l'écart de températures extrêmement chaudes ou froides pour veiller à ce qu'il soit utilisé dans la plage de fonctionnement indiquée.
- Lorsque vous installez des accessoires tels que des antennes, des coupleurs directionnels et des sondes de champ, prenez soin d'éviter toute exposition à des niveaux RF dangereux.
- Assurez-vous que rien n'est posé sur les câbles de votre équipement et que les câbles ne se trouvent pas à des endroits où l'on peut marcher dessus ou trébucher.
- Déplacez l'équipement avec soin ; veillez à ce que tous les câbles et/ou roulettes soient solidement raccordés au système. Évitez les arrêts brusques et les surfaces irrégulières.

AVANT LA MISE SOUS TENSION

Votre équipement AR peut disposer de plus d'un câble d'alimentation électrique. Utilisez uniquement un ou des câbles d'alimentation approuvés. Si un câble d'alimentation ne vous a pas été fourni avec l'équipement ou pour toute option alimentée en courant alternatif prévue pour l'équipement, achetez un câble d'alimentation qui est approuvé pour être utilisé dans votre pays. Le câble d'alimentation doit être prévu pour l'équipement et pour le courant et la tension indiqués sur l'étiquette de classement électrique de l'équipement.



Installer ou utiliser de façon incorrecte une tension de ligne incompatible peut augmenter le risque d'incendie ou d'autres dangers. Pour aider à éviter toute électrocution, branchez l'équipement et les câbles d'alimentation périphériques dans des prises électriques correctement mises à la terre. Ces câbles sont équipés de prises à trois broches pour veiller à une bonne mise à la terre. N'utilisez pas d'adaptateur de prise, ni ne retirez la broche de mise à la terre d'un câble.

Ne modifiez pas les câbles ou les prises d'alimentation. Consultez un électricien agréé ou un technicien d'entretien AR qualifié pour les modifications d'équipement. Respectez toujours les règles locales/nationales de câblage.



N'utilisez pas l'équipement s'il est physiquement endommagé ou s'il manque des pièces ou des panneaux.

MISE À LA TERRE DE SÉCURITÉ



Cet équipement est fourni avec une borne de mise à la terre de protection. La source d'alimentation secteur à l'équipement doit fournir une mise à la terre de sécurité ininterrompue de taille suffisante pour attacher les bornes de câblage, le cordon d'alimentation ou l'ensemble de câbles d'alimentation fourni. **N'UTILISEZ PAS cet équipement si cette protection est affaiblie.**

INSTRUCTIONS POUR UN FONCTIONNEMENT EN TOUTE SÉCURITÉ

TENSIONS RF DANGEREUSES

Les tensions RF sur la broche centrale d'un connecteur de sortie RF peuvent être dangereuses. Le connecteur de sortie RF doit être connecté à une charge avant que l'équipement ne reçoive l'alimentation en courant alternatif. N'entrez pas en contact avec la broche centrale du connecteur de sortie RF ou des accessoires raccordés à celle-ci. L'équipement doit être dans un état de non fonctionnement avant de déconnecter ou de connecter la charge au connecteur de sortie RF.



LIMITES ACOUSTIQUES

Si le bruit de l'équipement dépasse 80dB, une protection auditive est nécessaire.

AVERTISSEMENT CONCERNANT L'ENTRETIEN

Le réglage, l'entretien ou la réparation de l'équipement doivent être effectués uniquement par un personnel qualifié. Une énergie dangereuse peut être présente lorsque les couvercles de protection sont retirés de l'équipement, même si celui-ci est déconnecté de la source d'alimentation. Un contact peut causer des blessures. Les fusibles de remplacement doivent être d'un type et courant nominal spécifiques.

CONDITIONS ENVIRONNEMENTALES

Sauf mention contraire sur la fiche signalétique du produit, cet équipement est conçu pour être sécuritaire dans les conditions environnementales suivantes :

- Utilisation à l'intérieur
- Altitude jusqu'à 2000 m
- Température de 5°C à 40°C
- Humidité relative maximale de 80 % pour les températures jusqu'à 31°C. Décroissance linéaire à 50 % à 40°C.
- Les fluctuations de tension d'alimentation principale ne doivent pas dépasser ± 10 % de la tension nominale ou des valeurs d'autorégulation minimales et maximales.
- Degré de pollution 2 : Normalement non conducteur avec une condensation occasionnelle. Bien que l'équipement ne cause pas de condition dangereuse dans cette gamme environnementale, sa performance peut varier.

ÉQUIPEMENT CONTENANT DES LASERS



Les sondes de champ AR (série FL/PL) et les analyseurs de champ (série FA) sont des produits laser de classe 1 contenant des lasers intégrés de classe 4. Lors d'une utilisation normale, le rayonnement laser est entièrement contenu dans les câbles à fibres optiques et ne pose aucun risque d'exposition. Des verrouillages de sécurité veillent à ce que le laser ne soit pas activé à moins que les câbles ne soient correctement raccordés. Soyez toujours prudent lorsque vous utilisez ou entretenez des produits laser. Ne regardez pas directement avec des instruments optiques.

ANTENNES RF

- Cet équipement (antenne ou ensemble antenne) peut être lourd nécessitant deux personnes pour le soulever. Soyez prudent lorsque vous installez ou retirez l'unité. Respectez toutes les instructions concernant l'installation et le levage de l'équipement indiquées dans ce document.

- Assurez-vous que les connecteurs sont appropriés pour l'utilisation prévue. Les connecteurs sont indiqués dans le manuel d'utilisation et la fiche signalétique du produit.
- Ne dépassez pas le niveau d'entrée RF maximal indiqué dans les spécifications. Référez-vous au manuel d'utilisation et à la fiche signalétique du produit pour déterminer les niveaux RF applicables.
- Une entrée RF excessive pourrait endommager l'équipement ou les connecteurs causant des dangers pour la sécurité.
- Lorsque l'équipement fonctionne, les tensions RF sur les éléments de l'antenne peuvent être dangereuses. N'entrez pas en contact avec l'antenne ou les éléments lorsque le connecteur d'entrée RF est connecté à une source RF active.
- Pour éviter que le personnel ne se blesse et que l'amplificateur de puissance ou l'antenne ne soit endommagé, désactivez la sortie RF de l'amplificateur de puissance avant de brancher ou débrancher la connexion d'entrée à l'antenne.
- Effectuez des inspections périodiques de l'antenne et des systèmes de sondes de champ pour vérifier la date d'échéance de la calibration, le bon fonctionnement et l'état global de l'équipement.

MODÈLES TWT MONTÉS SUR BÂTI

Certains modèles TWT sont fournis sans le boîtier amovible proposé pour l'utilisation sur un plan de travail. Ces modèles montés sur bâti peuvent être fournis avec des poignées de transport ou des coulisses et poignées frontales. Respectez toutes les instructions de levage indiquées dans ce document et les instructions d'installation fournies dans le manuel d'utilisation TWT.

INSTRUCTIONS DE LEVAGE POUR L'ÉQUIPEMENT AR

Comme la plupart des produits doivent être manipulés pendant la distribution, l'assemblage et l'utilisation, le risque de blessures graves en raison d'une manipulation dangereuse du produit doit être une considération fondamentale pour chaque utilisateur. Une directive faisant autorité pour éliminer le risque injustifié de blessures causées par le levage est fournie par les méthodes de travail de NIOSH (publication n° 94-110) disponibles sur :



<https://www.cdc.gov/niosh/docs/94-110/pdfs/94-110.pdf>.

De façon générale, respectez les directives suivantes pour lever un poids de 50 lb (22 kg) ou plus :

- Utilisez uniquement l'anneau de levage (si posé au sol) ou les poignées latérales (si sur la table) pour soulever l'unité.
- Utilisez un équipement de capacité adéquate pour soulever et supporter l'unité.
- Si vous utilisez un chariot élévateur pour déplacer l'unité, assurez-vous que les fourches sont assez longues pour s'étendre au-delà du côté de l'unité.
- Pour plus d'informations, suivez le lien indiqué ci-dessus.

INSTRUCTIES VOOR VEILIG GEBRUIK



Neem de volgende veiligheidsrichtlijnen in acht om uw persoonlijke veiligheid te helpen waarborgen en uw apparaat en werkomgeving tegen mogelijke schade te beschermen.

BEOOGD GEBRUIK

Dit apparaat is bedoeld voor algemeen laboratoriumgebruik bij het genereren, regelen en meten van niveaus van elektromagnetische radiofrequentie(RF)-energie. Zorg ervoor dat het apparaat wordt gebruikt op een locatie die de uitgestraalde energie controleert, geen letsel veroorzaakt of de reglementaire niveaus van elektromagnetische interferentie schendt.

VEILIGHEIDSSYMBOLEN

Deze symbolen kunnen in uw gebruikershandleiding of op uw apparaat verschijnen.

	Dit symbool staat op het apparaat als de gebruiker de handleiding moet raadplegen voor belangrijke veiligheidsinformatie. Het waarschuwingssymbool geeft een mogelijk gevaar aan. Er moet aandacht worden besteed aan de verklaring om schade, vernietiging of letsel te voorkomen.
	Er zijn gevaarlijke elektrische spanningen aanwezig. Wees uiterst voorzichtig.
	Wijst op een terminal aan die bedoeld is voor aansluiting op een externe geleider voor bescherming tegen elektrische schokken in het geval van een storing, of de terminal van een veiligheidselektrode (aarding).
	Wijst op een onzichtbare laserstraling - bekijk niet rechtstreeks met optische instrumenten.
	Wijst op het frame of het chassis van de aardingsterminal.
	Wijst op wisselstroom.
	Geeft aan dat dit product niet bij het huishoudelijk afval mag worden weggegooid.
	Geeft aan dat het gemarkeerde oppervlak en de aangrenzende oppervlakken temperaturen kunnen bereiken, die warm aanvoelen.

VOORZORGSMAATREGELEN BIJ DE INSTALLATIE VAN HET APPARAAT



Raadpleeg de gebruikershandleiding en leer alle veiligheidsmarkeringen en -instructies kennen. De bescherming die door het apparaat wordt geboden, kan worden belemmerd bij gebruik op een manier die niet wordt vermeld door AR RF/Microwave Instrumentation (AR).

- Respecteer alle tilinstructies die in dit document vermeld zijn.
- Plaats het apparaat op een hard, waterpas oppervlak.
- Gebruik het apparaat niet in een natte omgeving, bijvoorbeeld in de buurt van een gootsteen of in een vochtige kelder.
- Plaats uw apparaat zodanig dat de aan/uit-schakelaar gemakkelijk bereikbaar is.

Revisie 0517

- Laat een vrije ruimte van 10,2 cm (4 inch) aan alle geventileerde zijden van het apparaat om de luchtstroom die nodig is voor goede ventilatie mogelijk te maken. Belemmer de luchtstroom in het apparaat niet door ventilatieopeningen of luchtinlaten te blokkeren. Het belemmeren van de luchtstroom kan leiden tot schade aan het apparaat, onregelmatige uitval van veiligheidscrisis's.
- Houd het apparaat uit de buurt van extreem hoge of lage temperaturen om ervoor te zorgen dat het apparaat binnen het gespecificeerde werkbereik wordt gebruikt.
- Bij de installatie van accessoires zoals antennes, directionele koppelingen en terreinsondes, moet u ervoor zorgen dat blootstelling aan gevaarlijke RF-niveaus wordt voorkomen.
- Zorg ervoor dat er niets op de kabels van uw apparaat rust en dat de kabels zich niet op een plaats bevinden, waar er op getrapt kan worden of waar er over gestruikeld kan worden.
- Verplaats de apparatuur voorzichtig; zorg ervoor dat alle zwenkwielen en/of kabels stevig op het systeem zijn aangesloten. Vermijd plotselinge stops en oneffen oppervlakken.

VOOR HET OPZETTEN VAN DE STROOM

Uw AR-apparatuur kan meer dan een netvoedingskabel bezitten. Gebruik alleen goedgekeurde netvoedingskabel(s). Koopt een netvoedingskabel die is goedgekeurd voor gebruik in uw land als u geen netvoedingskabel hebt ontvangen voor de apparatuur of voor een door wisselstroom aangedreven optie, die bedoeld is voor de apparatuur. De netvoedingskabel moet geschikt zijn voor het apparaat en voor de spanning en stroomsterkte die op het label met de elektrische classificatie van het apparaat staat vermeld.



Het verkeerd installeren of gebruiken van een incompatibele netspanning kan het risico op brand of andere gevaren verhogen. Sluit het apparaat en de perifere netvoedingskabels aan op geaarde stopcontacten om elektrische schokken te helpen voorkomen. Deze kabels zijn uitgerust met driepolige stekkers om voor een goede aarding te zorgen. Gebruik geen adapterstekkers of verwijder de aardingspen van een kabel niet.

Pas geen netvoedingskabels of stekkers aan. Raadpleeg een bevoegde elektricien of een door AR opgeleide servicemonteur voor aanpassingen van de apparatuur. Respecteer altijd uw lokale/nationale bedravingsreglementering.



Gebruik de apparatuur niet als er sprake is van fysieke schade, ontbrekende hardware of ontbrekende panelen.

AARDING



Deze apparatuur is voorzien van een beschermende aardingsterminal. De stroombron van de apparatuur moet een ononderbroken veiligheidsaarding van voldoende grootte leveren om de aansluitklemmen, de netvoedingskabel of de meegeleverde netvoedingskabelset aan te sluiten. **GEBRUIK dit apparaat NIET als deze bescherming is beschadigd.**

INSTRUCTIES VOOR VEILIG GEBRUIK

GEVAARLIJKE RF-SPANNINGEN

De RF-spanning op de middelste pin van een RF-outputconnector kan gevaarlijk zijn. De RF-uitgangconnector moet op een massa worden aangesloten voordat er wisselstroom op het apparaat wordt geplaatst. Raak de middelste pin van de RF-outputconnector of de accessoires die erop zijn aangesloten, niet aan. Plaats het apparaat in een niet-werkende staat voordat u de massa loskoppelt of verbindt met de RF-outputconnector.



AKOESTISCHE BEPERKINGEN

Als het geluid van het apparaat 80dB overschrijdt, is gehoorbescherming vereist.

ONDERHOUD WAARSCHUWING

Aanpassing, onderhoud of reparatie van de apparatuur mag alleen worden uitgevoerd door gekwalificeerd personeel. Er kan gevaarlijke energie aanwezig zijn terwijl beschermende afdekkingen van de apparatuur worden verwijderd, zelfs als deze van de stroombron is losgekoppeld. Contact kan tot persoonlijk letsel leiden. Wisselzekeringen moeten van het hetzelfde type en dezelfde stroomsterkte zijn.

OMGEVINGSVOORWAARDEN

Tenzij anders op het productspecificatieblad is vermeld, is dit apparaat ontworpen om veilig te zijn onder de volgende omgevingsomstandigheden:

- Binnengebruik
- Hoogte tot 2000 m
- Temperatuur van 5 °C to 40 °C
- Maximale relatieve vochtigheid 80% voor temperaturen tot 31 °C. Lineair afnemend tot 50% bij 40 °C.
- Schommelingen in de netspanning mogen niet groter zijn dan ± 10 % van de nominale spanning of minimum en maximum autobereikwaarden.
- Vervuilinggraad 2: Normaal niet-geleidend met incidentele condensatie. Hoewel het apparaat geen gevaarlijke toestand veroorzaakt boven dit omgevingsbereik, kunnen de prestaties variëren.

APPARAAT DAT LASERS BEVAT



AR-terreinsondes (FL/PL-serie) en terreinanalysatoren (FA-serie) zijn laserproducten van klasse 1 met ingesloten klasse 4-lasers. Bij normaal gebruik is de laserstraling volledig vervat in de glasvezelkabels en vormt ze geen bedreiging voor blootstelling. Veiligheidsvergrendelingen zorgen ervoor dat de laser niet wordt geactiveerd, tenzij de kabels correct zijn aangesloten. Wees altijd voorzichtig bij het gebruik of het onderhoud van laserproducten. Bekijk niet rechtstreeks met optische instrumenten.

RF-ANTENNES

- Dit apparaat (antenne of antenne-set) kan zwaar zijn, waardoor er twee personen nodig zijn om het op te tillen. Wees voorzichtig bij het installeren of verwijderen van het apparaat. Respecteer alle instructies voor het instellen en optillen van de apparatuur, die in dit document worden vermeld.
- Zorg ervoor dat de connectoren geschikt zijn voor de beoogde werking. De connectoren worden gespecificeerd in de gebruikershandleiding en in het productspecificatieblad.
- Overschrijd het maximale RF-ingangsniveau niet, dat in de specificaties is vermeld. Raadpleeg de gebruikershandleiding en het productspecificatieblad om de toepasselijke RF-niveaus te bepalen.
- Een overmatige RF-input kan het apparaat of de connectoren beschadigen en veiligheidsrisico's veroorzaken.
- De RF-spanningen op de antenne-elementen kunnen gevaarlijk zijn tijdens het gebruik. Raak de antenne of elementen niet aan wanneer de RF-ingangconnector is aangesloten op een actieve RF-bron.
- Om persoonlijk letsel en onopzettelijke schade aan de vermogensversterker of antenne te voorkomen, schakelt u de RF-output van de vermogensversterker uit voordat u de inputaansluiting op de antenne aansluit of loskoppelt.
- Voer periodieke inspecties uit van de antenne- en terreinsondesystemen om de vervaldatum van de kalibratie, de juiste werking en de algehele conditie van de apparatuur te controleren.

IN EEN REK GEMONTEERDE TWT-MODELLEN

Sommige TWT-modellen worden geleverd zonder de verwijderbare behuizing die wordt aangeboden voor gebruik als tafelmodel. Deze modellen die in een rek kunnen worden gemonteerd, kunnen worden geleverd met handgrepen of sledes en handgrepen die aan de voorkant zijn geïnstalleerd. Volg alle tilinstructies in dit document en de installatie-instructies in de gebruikershandleiding van de TWT.

TILINSTRUCTIES VOOR AR-APPARATUUR

Omdat de meeste producten tijdens de distributie, de assemblage en het gebruik moeten worden behandeld, moet het risico op ernstig letsel als gevolg van een onveilige behandeling van het product een fundamentele overweging voor elke gebruiker zijn. Een gezaghebbende richtlijn voor het elimineren van ongerechtvaardigd risico op letsel veroorzaakt door tillen, wordt aangeboden door de NIOSH-Work Practices (publicatie # 94-110) en is beschikbaar op:



<https://www.cdc.gov/niosh/docs/94-110/pdfs/94-110.pdf>.

Neem in het algemeen de volgende richtlijnen in acht voor het optillen van een gewicht van 25 kg of meer:

- Gebruik alleen het hijssoog (vloermodel) of de zijhandgrepen (tafelmodel) om de eenheid op te tillen.
- Gebruik apparatuur met voldoende capaciteit om de eenheid op te tillen en te ondersteunen.
- Als u een vorkheftruck gebruikt om de eenheid te verplaatsen, zorg er dan voor dat de vorken lang genoeg zijn om tot voorbij de zijkant van het eenheid uit te steken.
- Volg de link hierboven voor meer informatie.

TABLE OF CONTENTS

TABLE OF CONTENTS	i
1. INTRODUCTION	1
1.1 Probe Kit Description	1
1.2 Suggested Applications.....	1
1.3 Specifications.....	1
1.4 Accessories	2
2. THEORY OF OPERATION	9
2.1 Design of the Probe Kit	9
2.2 Probes	9
2.2.1 Sensors	9
2.2.2 Detectors	10
2.2.3 Preamplifiers.....	10
2.2.4 Optical Receiver/Power Supply	10
2.2.5 Optical Transmitter	11
2.2.6 Control Logic.....	11
2.2.7 Sampling	11
2.3 Probe Interface.....	11
2.3.1 Laser	11
2.3.2 Optical Receiver	11
2.3.3 Power Supply.....	11
2.3.4 Interfaces (IEEE, RS-232, F/O RS-232, USB).....	11
2.3.5 Control Logic.....	11
3. OPERATION	13
3.1 Warnings and Cautions.....	13
3.2 Laser Safety	13
3.2.1 Safe Operating Procedures and Precautions	13
3.3 General Guidelines For Use of Field Probes	14
3.3.1 Definitions of Terms as Used in This Manual	14
3.3.2 Guidelines for use of Field Probes.....	15
3.4 Probe Kit Appearance and Features.....	18
3.4.1 FL 7006 and FL7030 Probe	18
3.4.2 FL7218/FL7040/FL7060 Probe	19
3.4.3 Probe Interface.....	20
3.5 Installation	21
3.5.1 Unpacking.....	21
3.5.2 Mounting.....	21
3.5.3 Cooling Requirements	22
3.5.4 AC Line Power Connection.....	23
3.5.5 Remote Interface Connectors.....	23
3.6 Initial Turn-On and Warm-Up Procedure.....	23
3.7 Operating Protocols	23
3.7.1 RS-232 Operating Protocols.....	24
3.7.2 GPIB (IEEE-488) Operating Protocols.....	29
3.7.3 USB Operating Protocols.....	30
3.7.4 F/O Serial.....	31

4.	MAINTENANCE	33
4.1	General	33
4.2	Safety Warning.....	33
4.3	Unauthorized Repairs	33
4.4	Preventive Maintenance	33
4.4.1	Probe.....	33
4.4.2	Cables	34
4.4.3	Probe Interface	34
4.5	Return Procedure.....	34
4.6	Periodic Calibration.....	34
4.7	Upgrade Policies	35
Appendix A: Guidance for Orienting Stalk Type Field Probes		37
Appendix B: Dimensional Drawings.....		39

FIGURES

1-1	FL7006 or FL7030	1
1-2	FL7218/FL7040/ FL7060.....	1
1-3	FI7000 Interface	1
3-1	FL7006 and FL7030 Probe Features	18
3-2	FL7218/FL7040/FL7060 Probe Features	19
3-3	Interface Assembly Front Panel Features.....	20
3-4	Probe Interface Assembly Rear Panel Features.....	20
3-5	Interface Assembly Label Details	21

TABLES

3-1	FL7006 and FL7030 Probe Features	18
3-2	FL7218/FL7040/ FL7060 Probe Features	19
3-3	Interface Assembly Front Panel Features.....	20
3-4	Probe Interface Assembly Rear Panel Features.....	20
3-5	Interface Assembly Label Details	21
3-6	IEEE-488 Address Selection	30

1. INTRODUCTION

This manual provides operating, interfacing and selected service information pertinent to AR FL Series Electric Field Probe Kits; Models FL7006, FL7030, FL7218, FL7040 and FL7060. The FL7006 and FL7030 probes incorporate proprietary and patented sensor design. All models use miniaturized probe electronics to offer electric field probes for CW (continuous wave) electric field measurements.

1.1 PROBE KIT DESCRIPTION

The Laser Probe Kit includes a FL7006 or FL7030 Probe (Figure 1-1) or FL7218/FL7040/FL7060 Probe (Figure 1-2) and an FI7000 Interface (Figure 1-3). The probe communicates to its dedicated interface via supplied fiber optic cables and bulkhead feed through adapters. The interface provides standard communication protocols (RS-232, GPIB, USB 2.0) to the user's host computer to relay the measured field value. Field values relayed to the host may be further processed and/or displayed depending upon the host application program (software). Each Probe Kit comes with a carrying case to house all parts except the interface.

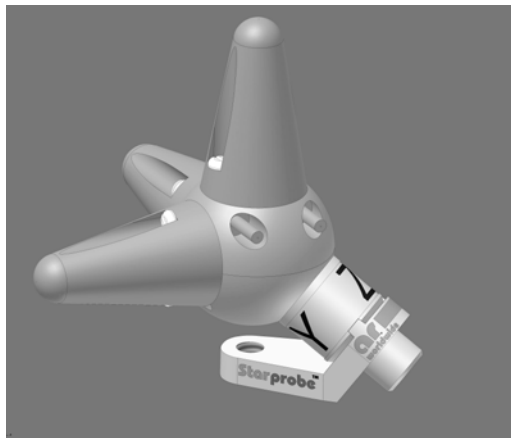

Figure 1-1. FL7006 or FL7030 Probe

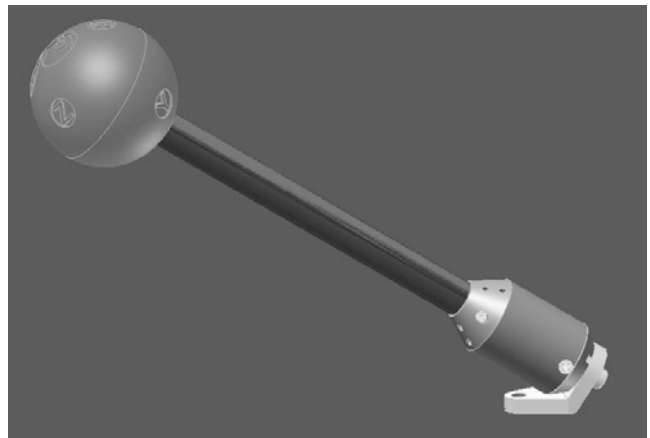

Figure 1-2. FL7218/FL7040/FL7060 Probe

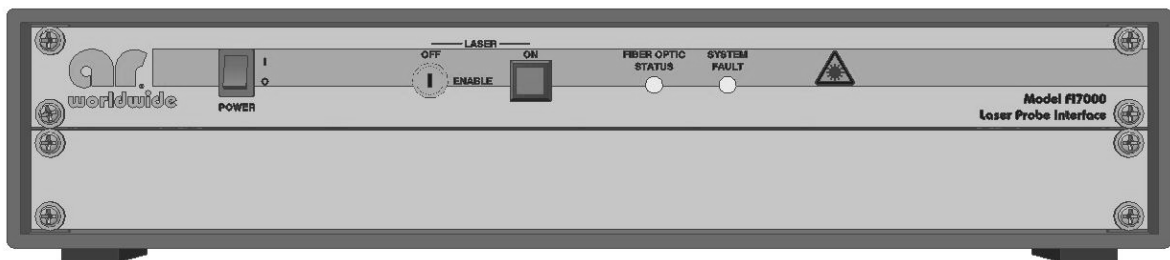

Figure 1-3. FI7000 Interface

1.2 SUGGESTED APPLICATIONS

- EMC field monitoring
- Electric field mapping

1.3 SPECIFICATIONS

Refer to the AR Specification sheets at the end of this section for detailed specifications of the kit, probe, and interface.

1.4 ACCESSORIES

AR offers a number of accessories for use with this probe kit.

- PS1000 probe stand, non conductive
- FM7004 Field Monitor.
- Long fiber optic cables for single length up to 100 m
- Bulkhead fiber optic cable feed through adapters (sets of two).
- VM7000 Virtual Field Monitor Software for PC.

FL7040/Kit

Electric Field Probe Kit

- 2MHz-40GHz
- 2-1000 V/m
- User-selectable X, Y, Z Axes

Features

The FL7040/Kit includes the equipment listed below. The FI7000 is housed in a 19" wide by 3.5" (2U) high instrument case with a 1.75 (1U) high blank panel. Please see individual product specification sheets for details.



Units shown not to scale.

Model FL7040/Kit Equipment List:

- Model FL7040 Probe with carrying case and Calibration Report from an A2LA-accredited lab
- Model FI7000 Probe Interface
- Model FC7010 Fiber Optic Cable set for FL7000 Series probes, 10 meters.
- Model MA7000 Fiber Optic Mating Adapter Set

NOTE: FM7004A is recommended for local monitoring and control.

Model	Description
FL7040/Kit	FI7000 Housed in 2U Instrument Case
FL7040/Kit M1	Rack Mount (Instrument Case removed)

AR RF/Microwave
Instrumentation
160 School House Rd
Souderton, PA 18964
215-723-8181

For an applications engineer call: 800.933.8181

www.arworld.us

To order AR Products, call 215.723.8181. For an applications engineer call: 800.933.8181. Direct to Service call: 215.723.0275 or email: service@arworld.us For Faxing Orders: 866.859.0582 (Orders Only Please) info@arworld.us
Approved for public release by AR RF/Microwave Instrumentation

102914

FL7040

Electric Field Probe

- 2MHz–40GHz
- 2–1000 V/m
- User-selectable X, Y, Z Axes



Features

The FL7040 is a smart, fast, extremely accurate electric field probe that contains an internal microprocessor to provide linearization, temperature compensation, control, and communication functions. Noise reduction and temperature compensation allow accurate measurements down to 2 V/m without zero adjustment. When rotated about its ortho angle mount, the probe provides isotropic response of ± 1.5 dB to 40 GHz.

The FL7040 is laser powered to allow for continuous operation without recharging or battery replacement. This probe requires an FI7000 for power and communication. FM7004A is recommended for local monitoring and control.

Correction factors are provided with the probe. These factors can be loaded into the Model FM7004A Field Monitor (sold separately) to automatically correct the probe readings at user-specified frequencies. When correction factors are applied, the true accuracy of the probe can be realized.

The FL7040 communicates through glass fiber optic cables, up to 100 meters long, to the FI7000 interface. X, Y, Z, and isotropic readings can be returned through an FI7000 in 20 msec.

FL7040 Typical Uncalibrated Frequency Response

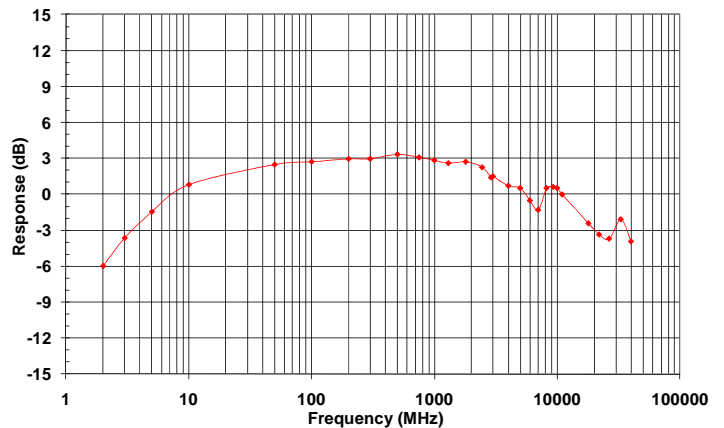

FL7040 Typical Calibrated Frequency Response (with correction factors applied)

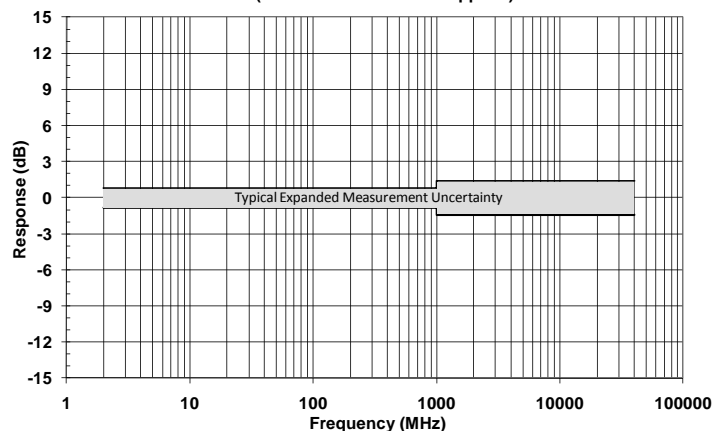

AR RF/Microwave
Instrumentation
160 School House Rd
Souderton, PA 18964
215-723-8181

For an applications engineer call: 800.933.8181

www.arworld.us

FL7040

Electric Field Probe

- 2MHz–40GHz
- 2–1000 V/m
- User-selectable X, Y, Z Axes

Specifications

Page 2

Amplitude Accuracy (field aligned with sensor axes):

Without correction factors applied: ± 1.0 dB @ 10 MHz

With correction factors applied: Typical expanded measurement uncertainty (95% confidence interval), 0.8 dB, 2 MHz–1 GHz; 1.4 dB, 1 GHz–40 GHz

Response Time/Sampling Rate (through FI7000): 20 msec/up to 50 samples per second at FI7000, USB and GPIB only

Isotropic Deviation (measured at the ortho angle): ± 0.5 dB @ 10 MHz; ± 1.5 dB, 2 MHz–40 GHz (typical)

Operating Range: 2–1000 V/m

Linearity, 2 to 1000 V/m: ± 0.5 dB

Temperature Stability: ± 0.5 dB over operating temperature range

Damage Level: 1200 V/m CW

Ranges: Single continuous range

Data returned from probe: X, Y, Z axes, and composite

Power Requirements: Laser powered from FI7000 interface

Dimensions: Approx. 278 x 65 x 65 mm (10.95 x 2.6 x 2.6 in)

Weight: Approx. 150 g (5.3 oz)

Operating Temperature Range: 10°C to 40°C (50°F to 104°F) @ 5% to 95% RH non-condensing

Fiber Optic Connectors: Two E2000 compact duplex connectors at 1 meter, includes fiber optic verification loop.

Calibration Data: Accredited Calibration Report (A2LA) supplied with probe

FI7000 Probe Interface

Features

The FI7000 interface provides both power to and communication with the FL/PL 7000 series probes. A low-level loop back fiber optic connection is used to sense unexpected disconnect of laser driven fibers to ensure user-safe operation. As an additional safety measure, shuttered connectors are used on all fiber optic connections to and from the probe.

The FI7000 can be used with the FM7004A Field Monitor (using the provided 0.5 meter fiber optic cable) or a PC by direct communication using the USB, GPIB, or RS-232 interfaces.



Specifications

Interfaces:

IEEE-488 (GPIB)
 USB 2.0, Test and Measurement class
 RS-232 (19200 Baud)
 Fiber Optic Serial (19200 Baud) reserved for connection to FM7004A Field Monitor
 Laser Fiber Optic Serial reserved for connection to one FL/PL 7000 series probe

Fiber Optic Connectors:

(2) E2000 compact duplex female for probe communication and safety fiber loop
 (2) FSMA for fiber connection to FM7004A

Laser: 500 mW, 830 nm

Laser shutdown time:

< 1 msec after fiber disconnect
 < 250 msec after loss of communication

Power Requirements:

Input Voltage 90-260 VAC, 50-60 Hz
 Input Current 0.2 - 0.6 A
 Input type IEC inlet with filter

Enclosure: Desktop case, 2U high; 1U blank panel installed.

Dimensions (WxHxD):

without enclosure 48.3 x 4.5 x 25.4 cm (19.0 x 1.75 x 10.0 in)
 with enclosure 49.8 x 12.7 x 30.5 cm (19.6 x 5.0 x 12.0 in)

Weight:

without enclosure 2.5 kg (6.25 lb)
 with enclosure 7.25 kg (16 lb)

Operating Temperature Range: 10°C to 40°C (50°F to 104°F) @ 5% to 95% RH non-condensing

Model	Description
FI7000	Housed in a 2U instrument case
FI7000M1	Rack mount (Instrument case removed)



Complies with 21CFR 1040.10 and 1040.11 except for deviations pursuant to Laser Notice # 50, dated June 24, 2007

AR RF/Microwave
 Instrumentation
 160 School House Rd
 Souderton, PA 18964
 215-723-8181

For an applications engineer call: 800.933.8181

www.arworld.us

To order AR Products, call 215.723.8181. For an applications engineer call: 800.933.8181. Direct to Service call: 215.723.0275 or email: service@arworld.us For Faxing Orders: 866.859.0582 (Orders Only Please) info@arworld.us
 Approved for public release by AR RF/Microwave Instrumentation

020816

2. THEORY OF OPERATION

2.1 DESIGN OF THE PROBE KIT

The Model FL7006/FL7030/FL7218/FL7040/FL7060 Probe Kit consists of two principal functional units: the probe and the probe interface. The two units are connected by two pairs of fiber optic (F/O) cables. Power to operate the probe and commands to the probe are provided from the interface on one of the F/O cables. Responses from the probe to the interface are provided on a second F/O cable. The other F/O pair is a safety loopback connection ensuring properly connected cables prior to laser turn on.

Each probe has been calibrated at the factory in a CW field at a single frequency, and the resultant calibration tables have been loaded into probe non-volatile memory. The calibration tables provide the basis for the conversion of the digitized signal, from the sensor/detector/pre-amplifier/A to D converter path, to electric field measurement values for each axis. A composite field level is then derived by calculating the square root of the sum of the squares of the individual axis field values. This calculation method is generally quite precise relative to the extent to which all the individual axis antenna patterns are those of very short electrical dipoles (sine function) at all frequencies.

In addition to the operating program and calibration tables (firmware), each probe's memory also contains the serial number of the probe, the revision of the probe's firmware, and the probe's most recent calibration date.

The probe interface sits between the probe and the host and provides all of the specified communication protocols to the host. The two functional units are described in greater detail below.

2.2 PROBES

The probes incorporate three orthogonal sensors, one for each axis, labeled X, Y and Z. The sensors feed detectors and the detected signals are routed through high-resistance leads to low noise preamplifiers in the housing. Circuitry within the housing, including a programmed micro-controller, processes the amplified detected levels to create a stream of digital information light encoded onto a fiber optic cable exiting the housing. Power (to operate) and commands to the electronic circuitry are received on a second fiber optic cable.

2.2.1 Sensors

2.2.1.1 FL7006 Sensor

Sensors in this probe include a simulated tapered resistance, and feed diode detectors. This configuration offers a nominally flat response with frequency. Sensors and detectors for each axis are housed in protective radomes. Additional details of the characteristics of sensors used in this series of probes are described extensively in United States Patent 6,593,896 granted July 15, 2003.

2.2.1.2 FL7030 Sensor

Sensors in this probe use a FET (Field Effect Transistor) preamplifier/buffer and feed diode detectors. DC power for the FET is supplied from a regulator in the housing. The FET preamplifier/buffer extends the low frequency response. The FET preamplifier/buffer offer a nominally flat response over the specified operating frequency range while additional RF filtering controls out of band response roll off. Sensors and detectors for each axis are housed in protective radomes.

2.2.1.3 FL7218/FL7040/FL7060 Sensor

Sensors in these probes include a resistance dipole, and feed a diode detector. This configuration offers a nominally flat response with frequency. Sensors and detectors for each axis are housed in a protective radome.

2.2.2 Detectors

2.2.2.1 FL7006 Detector

Each sensor is connected to medium barrier Schottky diode detectors. There are two diodes per probe axis to provide a balanced output.

2.2.2.2 FL7030 Detector

Each sensor is connected to medium barrier Schottky diode detectors.

2.2.2.3 FL7218/FL7040/FL7060 Detector

Each sensor is connected to a medium barrier Schottky diode detector.

2.2.3 Preamplifiers

2.2.3.1 FL7006 Preamplifier

The detected outputs of each sensor are fed to a balanced amplitude-compressive preamplifier. They offer dynamic bandwidth adjustment, so that larger amplitude signals exhibit a faster rise time yet small signal sensitivity is improved.

2.2.3.2 FL7030 Preamplifier

The detected output of each sensor is fed to an amplitude compressive preamplifier. The response time is limited by a low pass filter, offering an extended post-detection response-smoothing time constant to stabilize the reading over the specified operating frequency range.

2.2.3.3 FL7218/FL7040/FL7060 Preamplifier

The detected outputs of each sensor are fed to a balanced amplitude-compressive preamplifier. They offer dynamic bandwidth adjustment, so that larger amplitude signals exhibit a faster rise time yet small signal sensitivity is improved.

2.2.4 Optical Receiver/Power Supply

The probe is powered optically. The laser light is fiber-optically transmitted to the probe. The laser light is received via an efficient photon (light) power to electrical power converter. The electrical DC power is then regulated, split, re-regulated and distributed to power the probe. Commands to the probe arrive in serial optical format from relatively short interruption of the laser light. During receipt of commands, power for operation is maintained by using excess energy that was stored in capacitors during the laser-on time.

2.2.5 Optical Transmitter

The probe transmits responses via a low power optical transmitter, or photodiode. The photodiode is off, no light, when there is no transmission.

2.2.6 Control Logic

Functions within the probe are controlled by an on-board microcontroller. Analog-to-digital (A/D) converters are used to digitize the levels from the preamplifiers, the photon power converter voltage, and internal temperature. The microcontroller corrects these values using on-board calibration tables and processes all communication in and out of the probe.

2.2.7 Sampling

The control program (firmware) controls the collection of 12-bit A/D samples from each input in a rapid sequence, repeated for 16 samples of each input, and completed in 1200 microseconds. This is sufficiently short in time that the readings may be considered to have been taken at the *same* time. (For best accuracy users are advised to control the sample timing so as to request data when the field levels are not intentionally being changed. Untimed changes can typically be resolved by making several measurement samples and using values only after the readings have stabilized.) Typically, samples are taken only upon receipt of a host request for measurement. The sampled data is digitally processed to calculate the measured field level. The firmware applies probe specific factory generated probe calibration data. This data includes temperature correction data based on the internal probe temperature monitor.

2.3 PROBE INTERFACE

The FI7000 Interface provides power and communication to the probe and houses the laser light source, control logic, and communication interfaces.

2.3.1 Laser



The laser module provides photon (light) power to the probe. The laser module contains an embedded Class 4 laser with a peak output of 500mW and a wavelength of 850nm.

2.3.2 Optical Receiver

The optical receiver is a conventional-packaged photodetector.

2.3.3 Power Supply

All circuitry is powered by a single +5V DC power supply.

2.3.4 Interfaces (IEEE, RS-232, F/O RS-232, USB)

Refer to specific probe kit specifications interfaces to a host. All interfaces are controlled by the control logic

2.3.5 Control Logic

The control logic provides operational control and routing of signals. It includes a microcontroller. It functions to route the host commands, received from one specific controller/host interface, forward to the probe, and to route the probe responses backward to the same controller/host interface. Model-specific microcontroller firmware controls all aspects of the controller operation.

3. OPERATION

3.1 WARNINGS AND CAUTIONS

Throughout this manual, the symbol:



WARNING:

indicates that a hazard exists that may result in personal injury or loss of life.



CAUTION:

indicates that failure to follow procedures may result in damage to the equipment.



WARNING: DANGER - High Voltage Present:

The probe interface assembly operates from AC line voltages which may present a shock hazard.



WARNING: Safety Ground

Improper grounding of this equipment can result in electric shock. The unit must be operated only with a line cord with a safety ground wire. It is the user's responsibility to ascertain that the power connector is properly wired and that the power outlet is grounded.



LASER WARNING:

This Class 1 laser product contains an embedded Class 4 laser light source which may be hazardous. Only trained, qualified personnel should operate, maintain, and service it.



WARNING: Explosive Atmosphere

To avoid explosion, never operate this unit in an explosive atmosphere. This equipment is not certified for operation in an explosive atmosphere.

3.2 LASER SAFETY

This Class 1 laser product contains an embedded Class 4 laser with a peak output of 500mW and a wavelength of 850nm. Under normal use, the laser radiation is completely contained within the fiber optic cables and poses no threat of exposure.

3.2.1 Safe Operating Procedures and Precautions

To ensure safe operation, the following are recommended:

- Familiarize yourself with this manual and the safety information contained within.
- Be sure you understand the safe and proper use of this laser-powered field measurement system.

- Do not attempt to switch on the laser unless all of the fiber optic cables are attached.
- Do not attempt to switch on the laser if any of the fiber optic cables show signs of damage.
- Remove the key from the key switch when not in operation.
- Never manually force open the shutters on any of the fiber optic connectors. Damage to the connectors will result and laser radiation may escape.
- Never attempt to look directly or indirectly into the fiber ends. The fibers carry invisible light (sometimes laser) and serious injury to the eye may result.

3.3 GENERAL GUIDELINES FOR USE OF FIELD PROBES

This section relates to electric field probes in general.

3.3.1 Definitions of Terms as Used in This Manual

Response time for probe (or for probe interface).

Response time is the elapsed time from the end of the transmission of a specific *request* for data, to the end of transmission of the appropriate data *response* to the requesting device.

This time is transmission speed dependent. So this would not include the time to transmit the request, but would include the time to transmit the response. For a case in which the response is a 240 bit serial data string at 19,200 bits per second the response time could not be less than 12.5 ms. Response time will be longer to allow time for probe and interface calculations.

Time to valid reading for probe.

The time beginning after a field has stabilized, to the time at which a measurement of that field would be available to be read at a value within about 2 % of final value.

This would be about four time constants of the detector/amplifier response, plus the total defined sampling and A/D conversion and smoothing times. This time is not transmission speed dependent. [This time is field level dependent in certain AR probes, a longer time at low levels. The shortest time is in the sub ms range, longest in the 50 ms range, though it may be extended on some models to improve sensitivity.]

Request time

The time to prepare and transmit the request for data.

Detector Charge Time Constant

Detector charge time constant defines the limit of the response speed of the detected signal. It generally includes all factors that affect time constant up to the digitizing of the analog signal. This is usually assumed to be a single pole filter response and as such will have an exponentially changing level with time. When expressed as a time constant, user must allow at least several multiples of the time constant –time- to pass before the level to be read has stabilized, in order to produce an accurate reading with typical processing. A similar limitation occurs when a separate discharge time constant is specified.

The above definitions are useful for estimating the time after start at which to expect good data. However, a moderately sophisticated application program could just read the values continuously until receiving five or more reading which fall within a predefined (statistical) amplitude range, indicating that all processes have stabilized, before reporting the readings.

Axis Offset

The location of the center of each sensor element of three axis (X,Y,Z) field sensors is commonly *not at a single point* in space. This fundamentally has to do with the physical constraints of mounting more than one thing, a sensor and diode, in the same space plus other considerations related to a specific probe design. However, the *projections* of the axis of each sensor do commonly *intersect at a single point*. The axis offset is defined as the offset of the center of each sensor relative to the intersection of the three projected element axes.

Sensor Pattern

Sensor pattern is the sensitivity of the sensor as the sensor is positioned at various angles in a known field. The very short dipole sine shaped pattern is what permits the accurate combining of measurements from individual sensors to create a composite value. The location of the center of a dipole sensor is at the center of the dipole element. This is usually where the detector is located. To check the *field pattern* of an individual sensor in a field that is not known to be homogeneous over the test space, the rotation of an individual sensor should be about the center of the sensor.

Isotropy (Isotropic Deviation)

Isotropy (isotropic deviation) is the uniformity, or lack of uniformity, in the composite response of an isotropic probe over varying angles of probe orientation to a (constant) field.

3.3.2 Guidelines for use of Field Probes.

3.3.2.1 Probe Support Structures

It is *very* important to keep conductive objects away from a field probe. Any such objects in the proximity of the probe may distort the near field and compromise measurement accuracy. Always mount a probe on a non conductive (non metallic) platform using only non conductive (non metallic) hardware, including screws.

3.3.2.2 Probe Location

Probe location is a critical factor in the effective, efficient use of a measurement system. This is particularly true for the case of non-anechoic chambers, and in some anechoic chambers where the absorbers have limited effect. Here, high and low field nodes due to reflections and/or standing waves make probe location important. In such applications, it may be appropriate to dampen the room resonance via the application of strategically placed absorbers.

3.3.2.3 Probe Location in TEM cells

When used in a TEM cell, the size of a probe should not be large in relation to the dimensions of the TEM cell. Recommended maximum height for conductive portions of a probe is 1/3 of the TEM height- the septum to parallel wall surface space in which the probe is located.

3.3.2.4 Multiple probes

In a test environment in which the field around a unit under test (UUT) is to be monitored in an environment where large field gradients exist, the use of multiple probes can enhance the measurements. For example, two probes (one on either side of the UUT) or four probes (surrounding the UUT) may be used to increase the usefulness of the data. Use caution when placing a probe in proximity to a UUT or to additional probes as this can cause large errors in field measurement. As a rule of thumb maintain a minimum distance of 9 inches (23 cm) between adjacent probes. The minimum distance between a probe and a UUT is heavily dependent on the UUT and therefore must be determined by experimentation.

3.3.2.5 Out-of-Band Response and In-Band Response Considerations

Although the *specified* operating frequency range of a probe may be limited, probes typically respond to signals both above and below their *specified* frequencies. Users should be alert to unexplained readings that may be caused by unintended fields. These fields may be in-band *or* they may be out-of-band fields. Pay special attention to fields generated by a UUT or by test equipment located very close to a probe.

Probes can exhibit some response to frequencies as low as the 50/60 Hz line frequency. Locate operating probes well separated from AC power lines, and power supplies including switching power supplies.

Beyond the upper frequency limit, similar problems can occur. Beyond the specified upper operating frequency, the dimensions of the probe and any conductive enclosures (housing) *may* become appreciable in relation to ambient field wavelength. This can create responses that are variable due to pattern changes of the sensor or due to reflections from an electrically conductive housing.

In each case in which active field monitoring is to be used during UUT operation, it is recommended to first operate the UUT and test equipment together with the probe and *no test field* in order to determine the measured level of any ambient field. The ambient field level should be low enough to provide an error contribution consistent with the application requirements.

3.3.2.6 Harmonics

Attention should be paid that the error introduced by the level of harmonics, and any other carriers present in the field when a measurement is made, are consistent with the accuracy requirements. Probes using diode detectors have a varying sensitivity to harmonics and other carriers. At low field levels the detector typically operates in a square law range and the nominal effect of a harmonic is to add its *power* to the power in the fundamental to produce a reading. (Reading = square root of sum of squares of the two field levels.) At higher field levels the detectors may not be in their square law range and tend to respond more to the peak RF level. Readings are more likely related to the sum of the peak values of the field at each sensor location. This value will vary with the relative phases of the components. Only the bounds of the response are predictable.

Probe sensors using a single diode detector may produce different readings when the probe is inverted (rotated 180 degrees about the detector in the plane of the sensor). This may be more noticeable at higher field levels where detectors are not in their square law range. Some probe sensors incorporate diode detectors used in pairs to reduce this effect.

3.3.2.7 Noise Power

While all RF sources produce broadband noise, some produce more of this noise than others (notably TWTAs). This noise may produce (non-zero) readings on field probes. Although the noise is at a low noise power density level, the noise from broadband RF sources accumulates over the broad frequency range of the probe. This is usually resolved by operating the RF power source near to its rated power. Under this condition, the noise power level is low enough for most applications. Using space loss or other attenuation, or using a lower power amplifier (preferred for safety) are among the remedies. This effect is easily checked by operating the RF source with no carrier and observing the probe response.

3.3.2.8 Measurement of Isotropy

Since typical probes exhibit some axis offset, the offset will likely affect the common isotropy measurement (about a rotational angle) in which the rotational axis does not coincide with the sensor axis, unless this measurement is accomplished in a *known uniform field*. Since the rotating sensors are *moved* in the direction of propagation of the field, this *uniform field* is valid only for fields that exhibit a very small variation with distance from the source. This type of field can exist in TEM cells and in radiated fields far from the radiating

source. Spatial variations occur in close proximity to a radiating antenna creating a test field or in a GTEM with expanding dimensions, causing noticeable field changes with propagation distance. Caution should be exercised in the use of the composite measurement of *isotropic* probes when there is significant spatial variation in the field over the dimensions the probe. Repositioning the probe to adjust for the individual offset of each axis may produce a more consistent result.

3.3.2.9 Alignment with E-Field

To improve measurement accuracy, it is recommended that one axis of the probe always maintain alignment with the E-field being measured. This becomes more important the higher the E-field. See Appendix A for guidance on orienting stalk type Field Probes.

3.3.2.10 Calibration Reports

Each Field Probe is supplied with an initial calibration report and data. Within this data is a set of Correction Factors that should always be used when making field measurements. Correction Factors are typically supplied as multipliers as well as a dB value.

It is the responsibility of the user to apply Correction Factors. This can be done manually or through the use of a Field Monitor such as the Models FM7004A or VM7000 as well as with automated test software such as emcware®.

Correction Factors are always supplied by frequency. It is up to the user to select the Correction Factor that applies to the frequency of the E-field being measured. Quite often measurements are desired at frequencies that are not included in the Correction Factor list. In these situations, it is recommended that linear interpolation be used between adjacent frequencies.

Typically, Correction Factors are supplied at one amplitude with that amplitude being toward the lower end of the specified operating range. These Correction Factors can be applied throughout the entire amplitude range of the probe.

Additionally, linearity data is provided in the calibration report. This data is useful for understanding how linear the probe is over a portion of its specified operating range. The provided linearity data can be used as Correction Factors to correct measurement values over amplitude in addition to the Correction Factors supplied over frequency.

Most calibration reports will also contain a set of isotropic deviation values which are useful in understanding how much measured values can vary when alignment of one axis with the E-field is not maintained.

3.3.2.10.1 Applying Correction Factor Multipliers

To apply Correction Factor multipliers, simply multiply the measured field by the Correction Factor multiplier. This will yield the corrected field measurement in V/m.

$$\text{Measured Field (V/m)} \times \text{Correction Factor Multiplier} = \text{Corrected Measured Field (V/m)}$$

3.3.2.10.2 Applying dB Correction Factors

To apply a dB Correction Factor, the measured field provided by the probe must first be converted to a logarithmic scale. Once the field is in a log scale, the dB Correction Factor can simply be added. A conversion is then required to bring the corrected field value back to the original V/m units. The equations below show each step in this correction process.

$$20 \times \log_{10} \text{ Measured Field (V/m)} = \text{Measured Field (dBV/m)}$$

$$\text{Measured Field (dBV/m)} + \text{dB Correction Factor} = \text{Corrected Measured Field (dBV/m)}$$

$$10^{\frac{\text{Corrected Measured Field (dBV/m)}}{20}} = \text{Corrected Measured Field (V/m)}$$

3.4 PROBE KIT APPEARANCE AND FEATURES

3.4.1 FL 7006 and FL7030 Probe

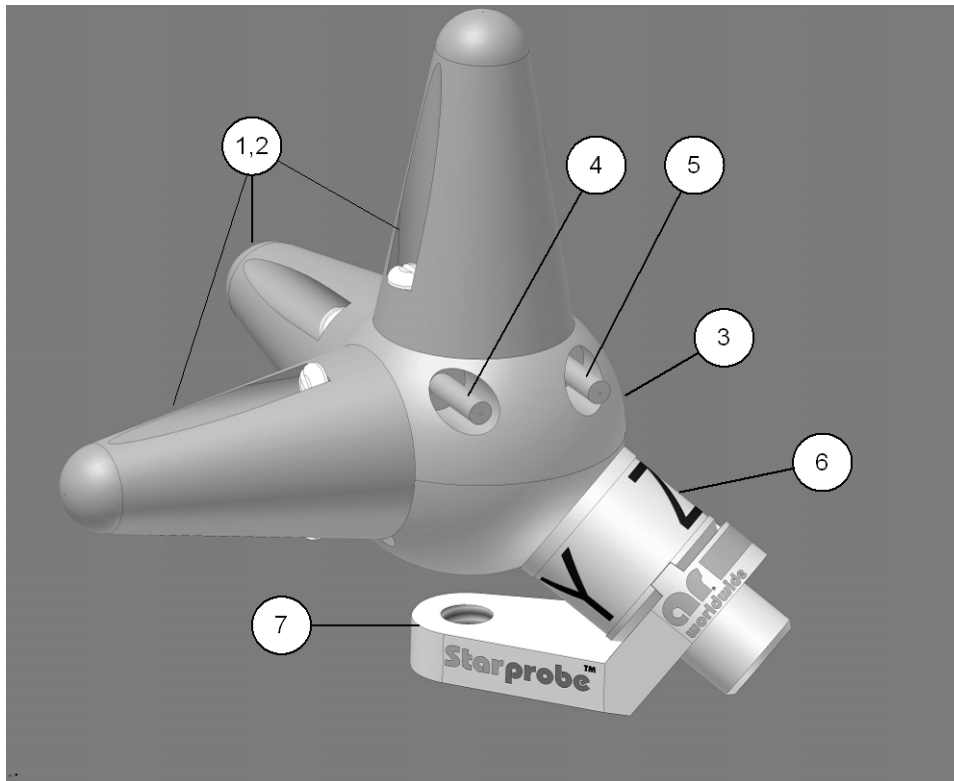

Figure 3-1: FL7006 and FL7030 Probe Features

Table 3-1. FL7006 and FL7030 Probe Features

Label	Title	Function
1	Sensor elements	Three antennas sensor elements to sense electric field. Each includes one or more diode detectors.
2	Radomes	Protects and supports the sensors
3	Housing	Protects and shields the probe electronic components
4	Fiber Optic Cable L	Routes laser (optical) power and commands to probe
5	Fiber Optic Cable X	Routes (optical) transmit data from probe
6	Probe Base	Provides mount via ¼ -20 screw. Rotation about screw axis brings each sensor through the same position.
7	Mounting Adapter	For mounting probe with a selected sensor axis aligned to a mounting screw axis. This is the normal mounting position when the probe is used to measure individual field axis (X,Y,Z) components.

3.4.2 FL7218/FL7040/FL7060 Probe

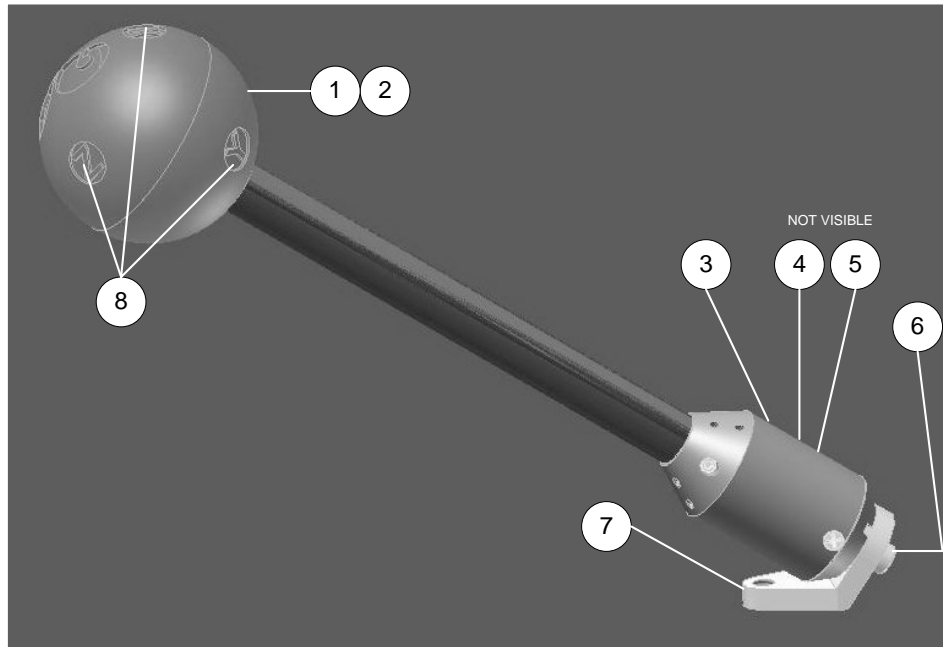

Figure 3-2: FL7218/FL7040/FL7060 Probe Features

Table 3-2. FL7218/FL7040/FL7060 Probe Features

Label	Title	Function
1	Sensor elements	Three antennas sensor elements to sense electric field.
2	Radome	Protects and supports the sensors
3	Housing & Protective Cover	Protects and shields the probe electronic components
4	Fiber Optic Cable L	Routes laser (optical) power and commands to probe
5	Fiber Optic Cable X	Routes (optical) transmit data from probe
6	Probe Base	Provides mount via ¼ -20 screw.
7	Mounting Adapter	For mounting probe with a selected sensor axis aligned to a mounting screw axis. This is the normal mounting position when the probe is used to measure individual field axis (X, Y, Z) components.
8	Axis Indicators	X, Y, Z markings indicate the tips of each dipole antenna.

3.4.3 Probe Interface

The Power switch on the interface activates the interface (ON) and deactivates the interface and probe (OFF). A separate key on the interface enables the laser. A momentary switch initiates the laser on sequence. If the fiber optic cables are not sensed or the probe does not respond within a preset time – as would be the case if the interconnecting fiber optic cables are not fully installed or damaged - the laser is turned off as a safety precaution.

Front panel indicators show that the AC power is applied, when the interface’s laser is on, F/O cable connection status and that the probe is responding.

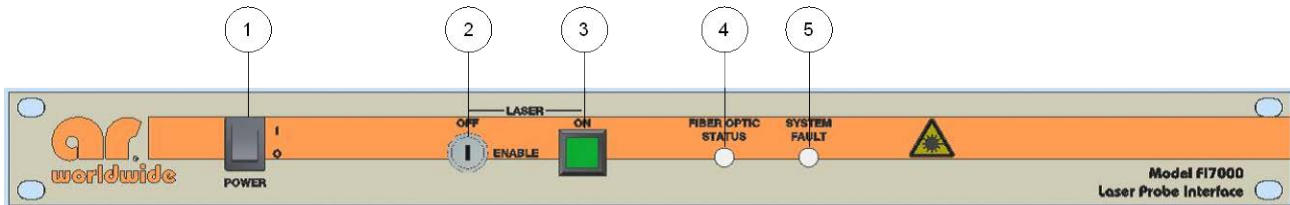

Figure 3-3: Interface Assembly Front Panel Features

Table 3-3 Interface Assembly Front Panel Features

Label	Title	Function
1	Power switch	Turns on the probe kit and illuminates to indicate that prime power is applied.
2	Key Switch	Enables the laser power supply.
3	Laser On Switch	Illuminated momentary switch to start laser on sequence. Switch is illuminated when laser is on.
4	F/O Status LED	Illuminates Green when F/O connection is sensed. Illuminates Red if cable fault is present.
5	System Fault LED	Illuminates Red if probe communication is terminated and F/O cable is still sensed. Off indicates safe condition (no faults).

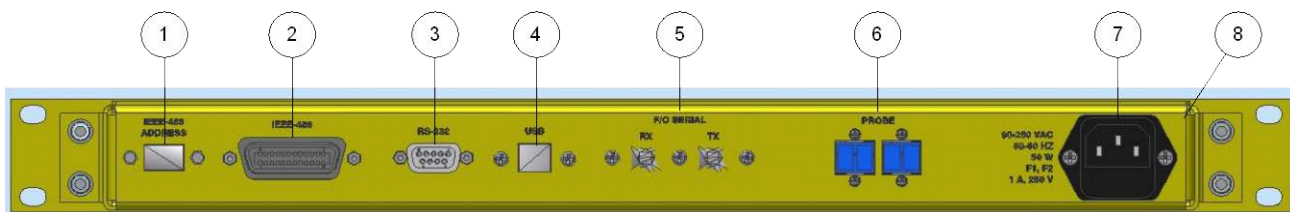

Figure 3-4. Probe Interface Assembly Rear Panel Features

Table 3-4. Probe Interface Assembly Rear Panel Features

Label	Title	Function
1	GPIB Address Switch	Sets device address for GPIB communication
2	GPIB (IEEE-488) Connector	GPIB connector to host
3	RS-232 connector	RS-232 Connector to host
4	USB Connector	Universal Serial buss connector to host
5	F/O Serial	F/O serial for connection to FM7004
6	Probe F/O Connection	(2) duplex E2000 F/O
7	Power	AC power input cable
8	Housing	Protects and shields the electronic components

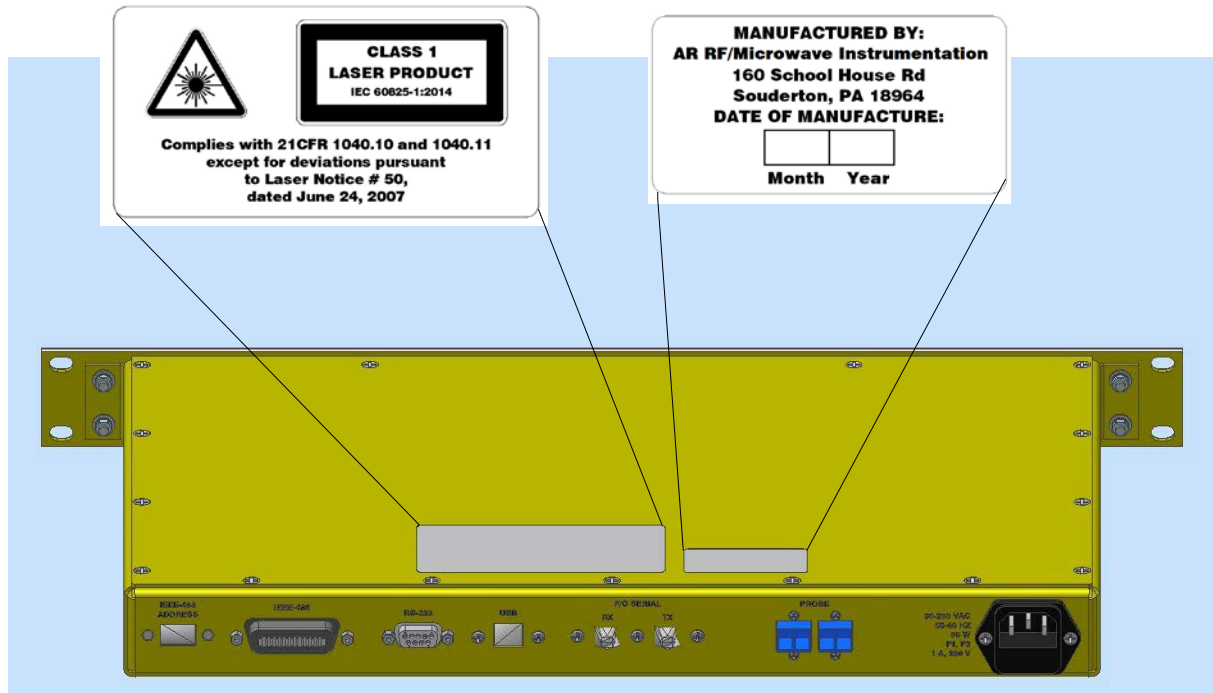

Figure 3-5. Interface Assembly Label Details

3.5 INSTALLATION

3.5.1 Unpacking

Upon receiving the probe kit, inspect the shipping container for obvious signs of external damage. If damage is observed, notify the carrier and contact an authorized service representative.

Unpacking:

1. Remove the probe from its shipping containers. Save the boxes and any protective packing materials for future use.
2. Open the carrying case, which holds all smaller items.
3. Check all materials against the packing list to verify that the equipment received matches the order. Note any discrepancies. If discrepancies are noted, or there are questions about the probe kit contents, contact AR Customer Service.
4. Be sure that you are satisfied with the contents of your order and the condition of your equipment before installing the probe kit.

3.5.2 Mounting

3.5.2.1 Probe Interface

The interface may be bench top mounted or rack mounted occupying 1.75" of internal rack space in a standard 19" rack.

3.5.2.2 Probe

The probe is designed to be mounted on a non-conductive (dielectric) probe stand. The stand should be supplied with a 1/4-20 non-conducting (dielectric) screw with 1/8 to 1/4 inch thread extending beyond the mounting surface.

For operation of stalked probes below 30 MHz, the stalk axis (the long axis of the probe) should not be aligned in the direction of the Electric (E) field. For this low frequency range it is recommended that the stalk axis be aligned with the direction of propagation, if it is known. For all other frequencies, it is recommended that the electronic housing be positioned more distant from the primary rf source than the position of the sensors, if the primary rf source location is known.

The probe has two permanently attached short fiber optic cables. Do not attempt to pull on these cables. Separately support these cables, or attach them to the probe stand on which the probe is mounted, to prevent accidental pulling of these fiber optic cables.

3.5.2.3 Fiber Optic Cable

The fiber optic cable should be routed using the minimum number of extension fibers in the links between the interface and the probe. Bulkhead fiber optic feed-through adapters may be used to attach one or two extension cables. Feed-throughs may be used un-mounted or may be panel mounted for penetration of screen room walls.

The fiber cable is rugged, but sharp bends (less than 1 inch radius) must be avoided. Position the fiber so that it is not subject to physical abuse and will not be walked upon. Do not put excessive stress on any fiber attachments. Support each cable to prevent accidental pulling at all fiber optic attachments.

The fiber optic cables are keyed and color-coded to ensure safe and proper connection. Shuttered connectors are used to prevent accidental exposure to laser radiation.

CAUTION:



Improper connections of the fiber optic cables can result in damage to the optical components.

Cables must be properly installed and connected before operating the probe kit.

3.5.3 Cooling Requirements

3.5.3.1 Probe Interface

The interface has no cooling requirements when operated within the specified temperature environment.

3.5.3.2 Probe

The probe generates little heat. The probe has been individually compensated to reduce variation with temperature. However, for best performance it should be operated in an area without excessive drafts or rapid changes in the ambient temperature.

3.5.4 AC Line Power Connection

AC line power connection to the probe interface is made at the AC inlet, which is a female IEC-320 connector. A line cord suitable for the type of AC outlet used, and consistent with local electrical codes, must be obtained to mate with this connector. Minimum wire size recommended for the line cord is 1.5 mm² (16 AWG).

3.5.5 Remote Interface Connectors

There are up to four types of connectors on the interface's rear panel:

- F/O RS-232 (for connection to FM7004 monitor)
- RS-232
- GPIB (IEEE-488)
- USB

RS-232 and USB are serial interfaces. GPIB is a parallel interface. The basic specific command and response sets are similar for each interface type on a particular model. Refer to specific interface type for operation.

3.6 INITIAL TURN-ON AND WARM-UP PROCEDURE

Operation is straightforward as described in prior sections of this manual.

After installation, turn on the Power switch on the probe interface. Observe the power on light. While allowing a warm-up of about 10 seconds, recheck that all fiber optic cables are connected. Check the F/O Status LED. Enable the laser power supply with the key switch. Press the laser on button once. Wait three seconds. Observe that the green Laser on indicator stays lit. This indicates that the probe is responding.

To completely turn the probe kit off, turn the power switch to the off position. To maximize laser life, turn laser off when not in use using key switch.

3.7 OPERATING PROTOCOLS

Operating protocols for the probe kit are described for three different electrical interfaces: RS-232, GPIB (IEEE-488), and USB. For each type of electrical interface, there are two categories of protocol: NORMAL and ERROR.

NORMAL protocol defines the operational protocol for use of the probe kit products in normal applications. Commands are to the probe kit and Responses are from the probe kit. A command to the probe kit may result in an ERROR response code. Error response codes are consistent with probe kit operation as needed. It is a goal of the probe kit to provide a proper NORMAL response to each command *or* a proper ERROR code in response to each command. Error codes focus on the interface, and the first item reported is generally sufficient. Identification of *internal* probe errors is not included in the product firmware, since there are no user serviceable items in the probe.

3.7.1 RS-232 Operating Protocols

3.7.1.1 Normal Operation Command/Response

This section lists the operating protocols RS-232 on the interface for normal operation.

Communication Protocol

Data Type:	RS-232 Serial
Data mode:	Asynchronous
Word Length:	8 bit
Parity:	None
Stop Bits:	1
Data Rate:	19,200 baud

RS-232 (DCE) Port Pinout Diagram DB-9 Female

Pin 1	DCD
Pin 2	TD
Pin 3	RD
Pin 4	DTR
Pin 5	GND
Pin 6	DSR
Pin 7	CTS
Pin 8	RTS
Pin 9	Unused

Information Transfer Protocol

The probe kit only responds to commands from another device. It transmits no data without first receiving instructions to do so.

All characters are defined by and transferred as common 7 bit ASCII characters.

Command Structure

A command string consists, in sequence, of:

- command letter
- parameter (optional)
- carriage return <CR>

Response Structure

In response to a command, the interface typically responds with a response string, in sequence, of:

- start character colon <:>
- command letter of the received command
- data (optional)
- termination character(s) *Note: Beginning with FI7000 firmware revision 2.70, the user can select the termination character(s) used for response strings.*

If a command is of a type that does not require the probe kit to return any data, the probe responds as above, but with no data field.

If a recognizable error occurs, the probe kit responds with an error code, as detailed in 3.7.1.2.

Commands to the probe kit must be sent one command at a time. Before sending another command, the host must wait for receipt of a complete response string (including the termination character(s)) from a prior command. Sending a command before receiving a response string will typically result in the new command being totally ignored. However, it may result in Error Code Responses.

To accommodate unrecognized errors, the host should have a timeout provision and an application program to take appropriate action in the event that there is no response within a certain time period after sending the command. It is recommended that the time period be on the order of one second.

Command To Probe Kit	Response From Probe Kit
Read Probe Data D<CR>	<p>Probe kit response structure: <start character><command letter><x axis field value ><y axis field value>< z axis field value><composite field value><status flag><termination></p> <p>:D<x><y><z><c><s><termination></p> <p>Where x, y, z, are 4 digit axis values, plus one floating decimal point after the 2nd or 3rd digit (in implied units of Volts/meter), c is the composite field value plus one floating decimal point after the 2nd or 3rd digit (in implied units of Volts/meter), and s is a status flag (S or X), where S indicates status is OK, X indicates status is not OK. (See <i>NOTE 1.</i>)</p> <p>Described in more detail:</p> <p>: = Start character ASCII colon (1 character)</p> <p>D = Command identifier (1 character)</p> <p>x = X axis field 4 digit value with ASCII decimal point (5 characters)</p> <p>y = Y axis field 4 digit value with ASCII decimal point (5 characters)</p> <p>z = Z axis field 4 digit value with ASCII decimal point (5 characters)</p> <p>c = Composite field 4 digit value with ASCII decimal point (5 characters)</p> <p>s = Status flag (S or X) (1 character)</p> <p>termination = Depends on the selected response termination characters (see TERM command for details) (1 or 2 characters)</p> <p>Character field separators are not used.</p> <p><i>NOTE 1: The returned status flag of S or X is determined by sampling the raw voltage on the output of the device used to convert the laser light into electrical power. An S is returned when this voltage is at or above a predetermined threshold level. An X is returned when this voltage is below the same predetermined threshold level. This threshold level has been selected based on statistical analysis of data collected during the design phase of the product series. An X indicates that the voltage has dropped to a level where there is the possibility of inaccurate data being generated. Monitoring of the status flag is recommended to ensure accurate data collection. The most common cause of a drop in this voltage level is dirt on the ends of the fiber-optic cable carrying the laser light.</i></p>

Command To Probe Kit	Response From Probe Kit
Read Probe Axis Data (X, Y, & Z only) A<CR>	Probe kit response structure: <start character><command letter><x axis field value ><y axis field value>< z axis field value><status flag><termination>

:A<x><y><z><s><termination>

Where x, y, z, are 4 digit axis values, plus one floating decimal point after the 2nd or 3rd digit (in implied units of Volts/meter), and s is a status flag (S or X), where S indicates status is OK, X indicates status is not OK. (See NOTE 1 on previous page.)

Described in more detail:

- : = Start character ASCII colon (1 character)
- A = Command identifier (1 character)
- x = X axis field 4 digit value with ASCII decimal point (5 characters)
- y = Y axis field 4 digit value with ASCII decimal point (5 characters)
- z = Z axis field 4 digit value with ASCII decimal point (5 characters)
- s = Status flag (S or X) (1 character)
- termination** = Depends on the selected response termination characters (see TERM command for details) (1 or 2 characters)

Character field separators are not used.

Read Probe Identification I<CR>	Probe kit response structure: <start character>,<command letter>,<model>,<serial number>,<firmware rev level>,<probe calibration date>,<status flag>,<termination>
---	--

:I,<m>,<n>,<r>,<d>,<s>,<termination>

where:

- , = Separator character ASCII comma (6 characters used as separator)
- : = Start character ASCII colon (1 character)
- I = Command identifier (1 character)
- m = probe model designation (6 characters)
- n = probe serial number (8 characters)
- r = probe firmware revision (10 characters)
- d = probe linearization date (8 characters)
- s = Status flag (S or X where S indicates status OK and X indicates status not OK) (1 character)
- termination** = Depends on the selected response termination characters (see TERM command for details) (1 or 2 characters)

Total number of characters is variable. [subject to change]

Command To Probe Kit	Response From Probe Kit
Read Probe Interface Identification command *IDN?<CR>	Response structure: <manufacturer>,<model>,<firmware rev level> <f>,<m>,<r><termination> where: , = Separator character ASCII comma f = manufacturer, AR or AR WORLDWIDE (1 to 18 characters) m = Interface model designation (1-6 characters) r = Firmware revision level (0-10 characters) termination = Depends on the selected response termination characters (see TERM command for details) (1 or 2 characters) Total number of characters is variable.
Read Probe Interface Serial Number command SN?<CR>	Response structure: <serial number> <s><termination> where: s = serial number (1 to 10 characters) termination = Depends on the selected response termination characters (see TERM command for details) (1 or 2 characters) Total number of characters is variable.

Command To Probe Kit	Response From Probe Kit
Set Response Termination Character(s) TERMn<CR>	Where: n = 0 to 3 0 = <LF><CR> <i>factory default (for compatibility with legacy control software)</i> 1 = <CR><LF> 2 = <LF> 3 = <CR> <i>Note 1: After this command is sent, a query response is automatically generated reflecting the present termination setting.</i> <i>Note 2: Setting is retained when power is cycled.</i> <i>Note 3: Selection 0 must be used for compatibility with FM7004A and VM7000.</i> Response Structure: TERMn<termination> <i>(see above for variable definition)</i> termination = Depends on the selected response termination characters (1 or 2 characters)
Query Response Termination Character(s) TERM?<CR>	

3.7.1.2 Error Code Responses

Error code responses are transmitted from the probe kit due to errors detected during operation upon receipt of a serial input. The general format is similar to other responses. When an error has been recognized and an error code has been generated, the probe kit will generally check and then clear its input buffer until a new start character is received. Specific responses are as listed below. Recommended actions are shown in brackets []. <termination> depends on the selected response termination characters (1 or 2 characters).

Format: **Ex** where **x = a....z**

Code	Command	Detail
Ea<termination>	Framing error	Indicates that corrupted data has been recognized by the probe kit, and that no further processing is to be done on this data string.
Eb<termination>	Input buffer error	Overflow, command has been lost due to probe failure to process some input character in time and the input character has been lost. [Either there is a problem with the probe kit, or data is coming too fast and this advises that host should send characters with more time between characters.]
Ec<termination>	Communication format error	Start character received, but no stop character <CR> received within approximately 5 seconds of a start character, and probe input buffer has been cleared. The long time is to allow for a command to be entered by an operator using a keyboard. [Host should retransmit the previous command and insure that future

Code	Command	Detail
		command strings are fully sent with less than 5 seconds between each character.]
Ed<termination>	Buffer full error	Too many characters contained between the Start Character and the Carriage Return of a command. Message is not processed by the probe kit. [Host should send correct string.]
Ee<termination>	Invalid command first character	The received command is not a valid command per the command list for the probe kit. Specifically, the first character of the command is not one of the valid first characters of any acceptable command. [Host to check command]
Ef<termination>	Invalid command additional character(s)	The additional parameters contained in a received command are not valid. Specifically the additional characters, after the first character in a command, are not valid additional characters for this type of command for the probe kit. [Host to check command.]
Eg<termination>	Probe hardware error	An error has been detected by limited error detection in the probe (not the interface) and it has been determined that this error will cause the requested response to be unreliable, so the requested response is not sent. [Host should try the command again to see if this probe error clears. If error does not clear probe needs to be repaired. Note that since the probe is not user repairable, there is no reason for further fault detection in the probe.]
Eh<termination>	Laser not on error	Commands cannot be sent to or received from the probe without the laser power on. [Turn laser on from front panel and check for fault status.]

3.7.2 GPIB (IEEE-488) Operating Protocols

3.7.2.1 IEEE-488 (GPIB) Communications

For IEEE-488 operation, the device address is set using the dip switches on the rear panel of the product. Ensure that each device connected to the IEEE-488 buss is set to a unique address. (Resetting the address requires re-booting the unit).

Specific IEEE-488 bus commands depend on which software package you are using. To send commands be sure that the Field Monitors address is set properly and that the controller has correctly identified the unit as a “listening” device.

When sending commands to the unit via the GPIB interface, the command must be terminated with an **EOI**.

3.7.2.2 Setting the IEEE-488 (GPIB) Address

The IEEE-488 device address can be set to any number between 1 and 30. This selection is made by setting Switches 1 to 5 of the rear panel DIP switch to the binary equivalent of the number. Table 3-6 illustrates this switch selection. Please note that although addresses 0 and 31 can be entered, neither address is valid for this device, and therefore should be avoided.

Table 3-6. IEEE-488 Address Selection

Device Address	Switch 1	Switch 2	Switch 3	Switch 4	Switch 5
0	DO NOT USE - (RESERVED FOR CONTOLLER)				
1	on (1)	off (0)	off (0)	off (0)	off (0)
2	off (0)	on (1)	off (0)	off (0)	off (0)
3	on (1)	on (1)	off (0)	off (0)	off (0)
4	off (0)	off (0)	on (1)	off (0)	off (0)
5	on (1)	off (0)	on (1)	off (0)	off (0)
:					
30	off (0)	on (1)	on (1)	on (1)	on (1)
31	DO NOT USE				

3.7.2.3 Normal Operation Command/Response

Communication Protocol

Data Type: GPIB (IEEE-488)
 Data mode: Asynchronous parallel
 Word Length: 8 bit

Information Transfer Protocol

The probe kit only responds to commands from another device. It transmits no data without first receiving instructions to do so.

Uses the **Normal Operation Command/Response** as defined for RS-232.

3.7.2.4 Error Code Responses

Uses the **Error Code Responses** as defined for RS-232.

3.7.3 USB Operating Protocols

The USB port on this product is a USB 2.0 port. It also complies with the USB Test and Measurement Class Standard. Communications with this port requires the host computer to have a USBTMC driver available. All commands and queries through this port must be terminated with a <CR>.

The cable required to make this connection is a USB 2.0 A-B peripheral device cable. The cable can be no longer than 5 meters. If a longer distance is required a USB hub must be used. A cable carrying the official USB logo is recommended.

When connected to a PC running Windows 2000 or XP a window will pop-up labeled Hardware Wizard. If this PC has National Instruments LabView installed it will have a USBTMC driver that will work with this port. This driver will allow the device to be easily controlled using National Instruments Measurement and Automation Explorer or LabView. If a user wishes to write code in a different programming language, a custom driver can be requested from AR. It should be noted that the USBTMC driver provided by National Instruments is a VISA driver which can be used with other programming languages besides LabView. For more information on this please consult the National Instruments Website found at www.ni.com.

NOTE: All firmware updates are done through the USB port.

3.7.3.1 Normal Operation Command/Response

Uses the **Normal Operation Command/Response** as defined for RS-232.

3.7.3.2 Error Code Responses

Uses the **Error Code Responses** as defined for RS-232.

3.7.4 F/O Serial

Dedicated port for connection to FM7004 monitor.

4. MAINTENANCE

4.1 GENERAL

The probe kit does not require routine scheduled maintenance. The only moving parts are the elements of switches. Preventive maintenance is recommended in Paragraph 4.4.

The probe kit is a factory-repairable item with the exception of items specifically listed in the section. No logic diagram or schematics or detailed parts information is supplied in this manual.

4.2 SAFETY WARNING

WARNING: DANGER - High Voltage Present:



The Laser Probe Interface assembly operates from AC line voltages which may present a shock hazard.

LASER WARNING:



This Class 1 laser product contains an embedded Class 4 laser light source which may be hazardous. Only trained, qualified personnel should operate, maintain, and service it.

4.3 UNAUTHORIZED REPAIRS

CAUTION:



Unauthorized repairs or modification of this product during the warranty period may void the warranty. In the event that the kit malfunctions while it is still under warranty, always contact an authorized service representative.

Contact AR Customer Service for return authorization before returning any part of the probe kit for repair or replacement.

4.4 PREVENTIVE MAINTENANCE

The probe kit has been calibrated at the factory and should maintain its calibration for a long period of time if not physically abused. Periodically check that the probe kit is functioning by applying a known low level field to the probe and reading the level on the host to check that the unit is operating.

4.4.1 Probe

Periodically inspect probe for physical damage. There are no user repairable parts.

Keep the exterior of the radomes clean. Foreign materials may become embedded in the surface. Radomes must be kept clean and dry and contaminant free to maintain proper probe operation. To clean, wipe with a damp cloth and dry with a dry cloth. Use a small amount of soap or a mild detergent only if necessary to fully clean the surface.

If damage to the probe is observed, return to factory for repair.

4.4.2 Cables

Periodically inspect fiber optic cables for physical damage. Replace damaged cables. **Do not manually force connector shutters open. Damage to the connectors will result and laser radiation may escape.**

4.4.3 Probe Interface

Periodically inspect the interface for physical damage. There are no user-repairable parts in the interface. The laser module in the interface is factory-replaceable with one of the same type without requiring recalibration of the probe kit. The laser used in the interface will gradually degrade in light (optical) output over its operating life. Noticeable degradation is likely in about 10,000 operating hours. The unit as delivered has adequate optical power margin to allow for some degradation under specified operating conditions. The light output reduction prior to noticeable performance degradation varies by model and application conditions and is affected by the number and length of fiber cable extensions.

If damage to the interface is observed, return to the factory for repair.

4.5 RETURN PROCEDURE

To return a Field Probe to AR, use the following procedure:

1. Contact the AR Customer Service Department.
2. Briefly describe the problem in writing. Give details regarding the observed symptom(s), and whether the problem is constant or intermittent in nature. If AR has been previously contacted about the problem, provide the date(s), identify the contact and the nature of the contact.
3. Package the Field Probe kit carefully. Use the original shipping case, boxes and packing materials, if possible.
4. To return an item, contact AR Customer Service for an RMA number and shipping instructions. Returns from outside the United States are not permitted without prior authorization. If shipping from outside of the United States, closely follow all directions on the RMA form for return shipping and marking.

If the Field Probe is still under warranty, refer to the Limited Warranty for additional information about your return.

4.6 PERIODIC CALIBRATION

The frequency of calibration and level (grade) of calibration should be determined by the user after carefully considering the application requirements. Normal considerations include field accuracy requirements, test environment, mode of use, frequency range and field level range. Users may wish to refer to IEEE Std 1309-2013 for guidelines in specifying and selecting the calibration details. This standard includes consensus calibration methods for many different field probes, including recommendations for probe types that are similar to this probe kit.

Prior to returning a probe kit for calibration, the user should specify what type of calibration is requested, standard or custom, and request a quote for the calibration. User can specify normal AR calibration (standard) for this probe kit, or specify other calibration desired (custom) using Form 647. To avoid confusion, the user must specify in writing the required calibration when returning probe kit for calibration.

If not otherwise specified by the user in the calibration order, AR will verify that the probe kit is performing within specifications by performing a subset of testing equivalent to the test performed on this unit when

shipped. This test subset may be changed by AR, depending upon the calibration performance history on this type of probe kit. To obtain a quotation and arrange for calibration, contact AR.

AR recommends a one year calibration interval (beginning after the date of shipment) of the probe kit.

4.7 UPGRADE POLICIES

Probe kit firmware is periodically upgraded to enhance functionality. Contact AR Customer Service to check on the upgrade status for your probe(s).

Appendix A: Guidance for Orienting Stalk Type Field Probes

It is always best to maintain alignment of one axis of a Field Probe with the E-field being measured. For a stalk type Field Probe, this can be accomplished by using the axis labels on the orange ball of the sensor head. The tips of each of the three dipole antennas are indicated with an X, Y, or Z. Using the provided angle mount at the base of the Field Probe makes alignment of each axis straight forward (See Figure A-1).

Additionally, it is recommended that one of the off-axis antennas be positioned both orthogonally to the E-field and orthogonally to the direction of propagation, while the other off-axis antenna be aligned with the direction of propagation. This is achieved by pivoting the Field Probe 45° from the direction of propagation (See Figure A-2). Using this mounting configuration allows the Field Probe to be easily re-positioned when changes in antenna polarization occur. For example, if the X axis is aligned with a vertical E-field and the transmitting antenna polarization is then changed to horizontal, re-aligning the X axis with the E-field is as simple as loosening the thumb screw on the angle mount and rotating the probe 120° about the axis of the stalk.

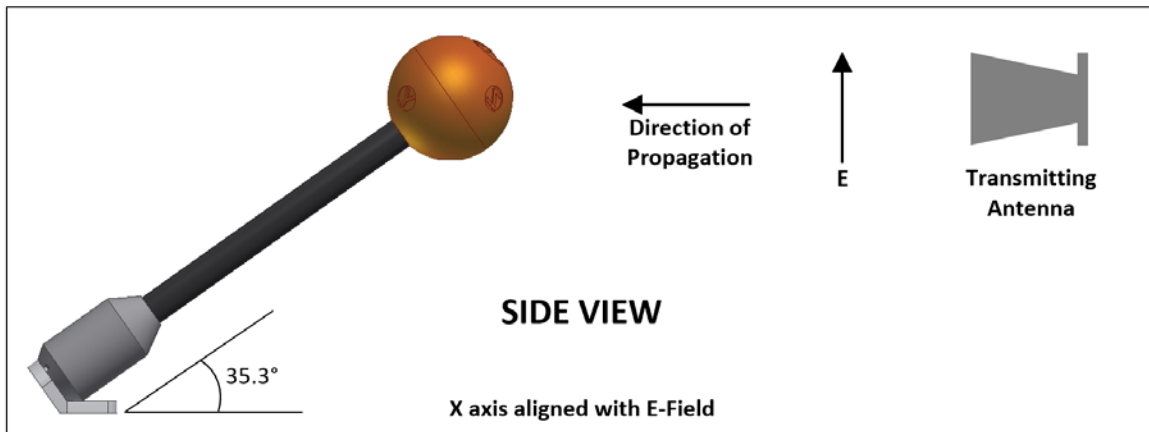

Figure A-1.

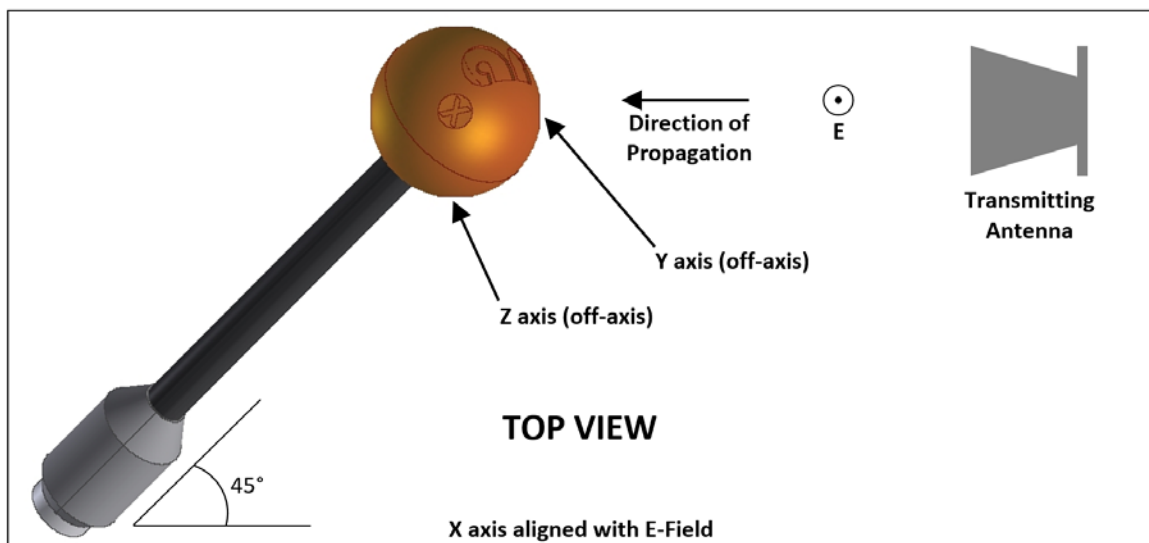

Figure A-2.

Appendix B: Dimensional Drawings

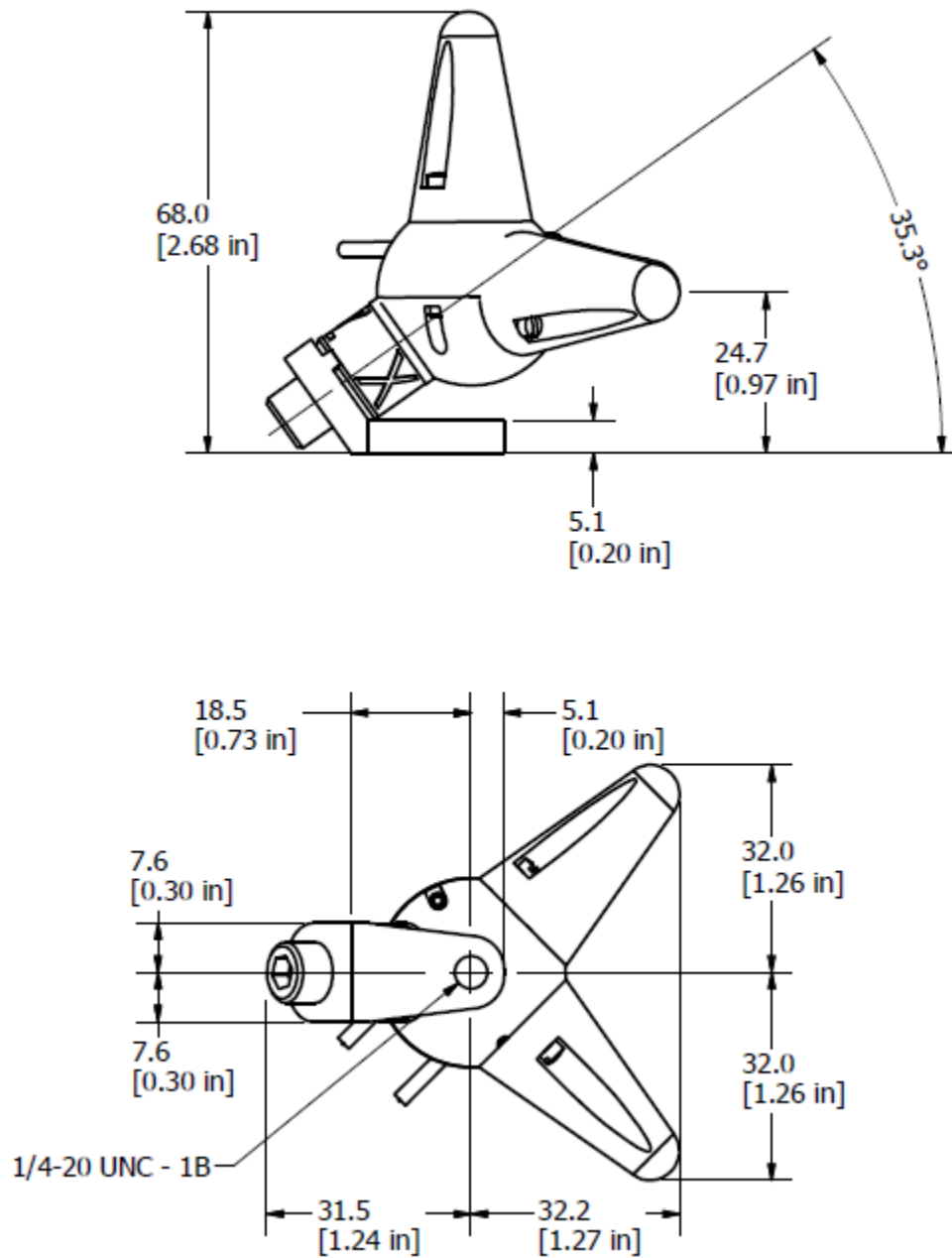

Figure B-1. Models FL7030 & FL7006

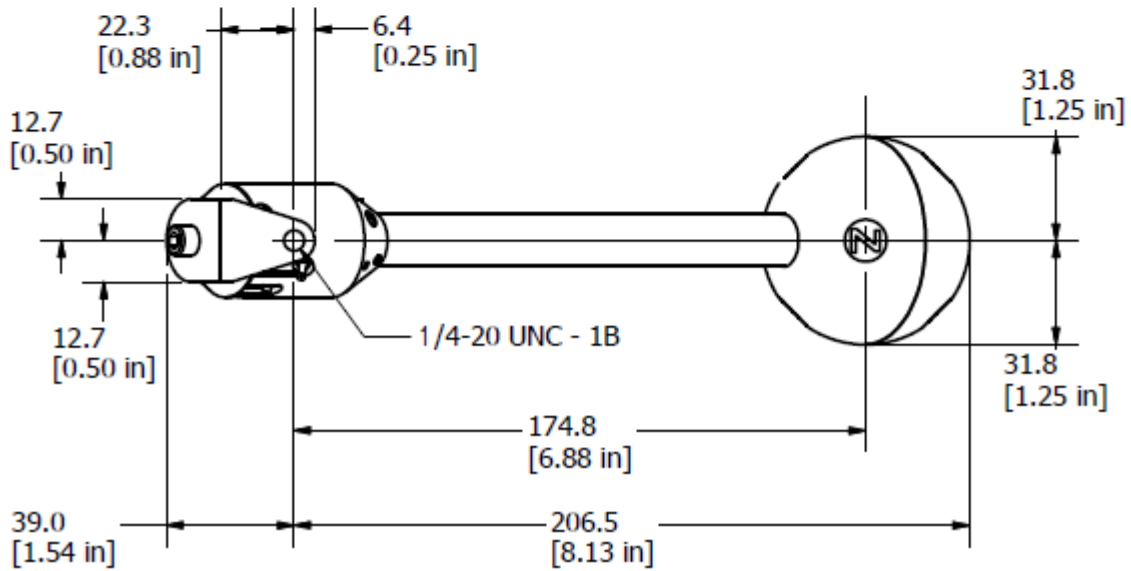
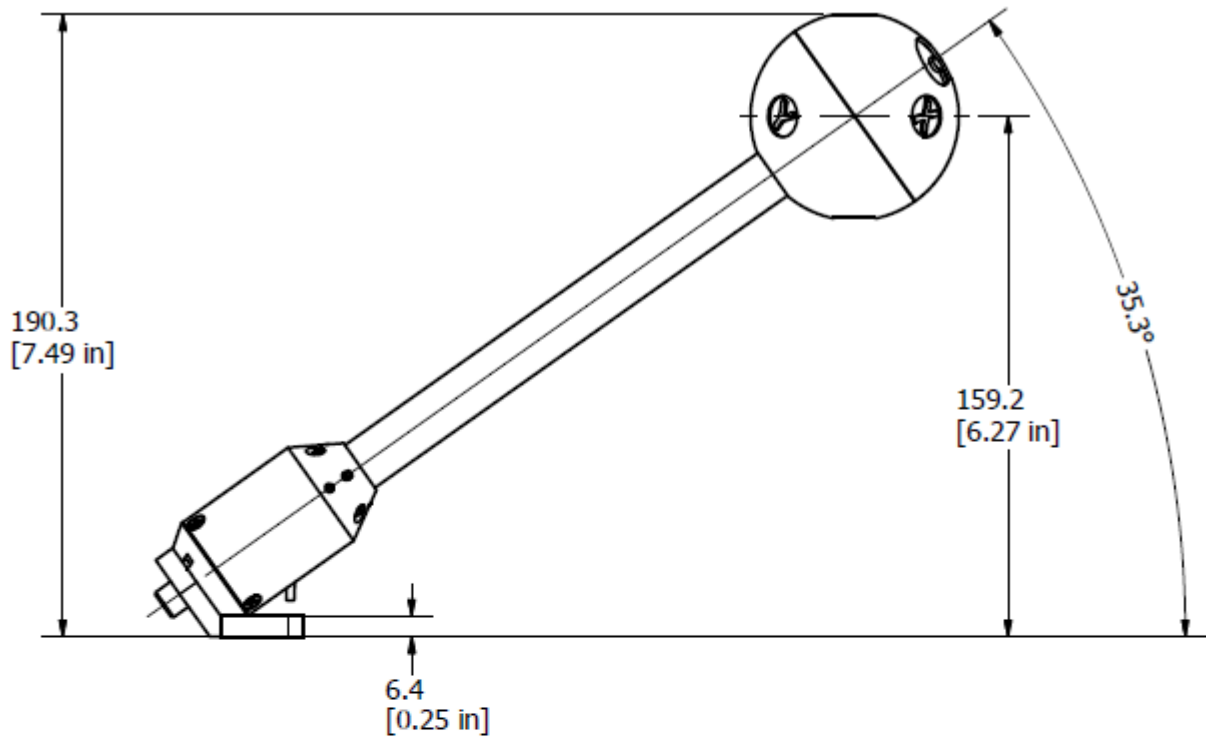

Figure B-2. Models FL7218, FL7040 & FL7060

WARRANTIES: LIMITATION OF LIABILITY

Seller warrants (i) that seller has title to the goods sold and (ii) that Amplifiers (all parts excluding traveling wave and vacuum tubes), Antennas, field monitors, field probes, field analyzers, field analyzer processor units, system controllers, system interlock, power meters, leak detectors, RF conducted probes, RF conducted clamps, Multi-tone, EMI receiver systems, RF down converters, RF conducted immunity systems, conducted immunity accessories, radiated immunity test systems, safety meters, safety sensor heads, tripods, directional couplers, waveguide adapters, termination loads, load attenuators, impedance stabilization networks, and coaxial cables will be free from defects in material and workmanship for a period of three (3) years from date of shipment shown on AR RF/Microwave Instrumentation invoice.

All modules, used in the amplifiers for the 1-6 GHz, 4-18 GHz, 6-18 GHz, all HPM products, and other applications, are hermetically-sealed. This sealing process protects the internal hybrid circuitry from humidity that could compromise the long term reliability of the product. These modules are not field-repairable and should *never* be opened outside of AR's Microelectronics Lab. The modules in these product lines have a security label on two sides of the modules between the housing and lid/cover. If the security label is removed and or cut, the warranty of the module will be voided.

Vacuum tubes in the 'L' series amplifiers, traveling-wave tubes in TWT amplifiers, and power heads will be free from defects in material and workmanship for a period of one (1) year.

Contact AR RF/Microwave Instrumentation for warranty information regarding items not listed.

Seller's sole responsibility in fulfilling these warranties shall be to repair or replace any goods which do not conform to the foregoing warranties or, at seller's option, to give buyer credit for defective goods. The warranty is valid only when used in the country specified at time of order. Warranty service must be obtained from the repair facility designated at that time. If warranty service is not available in the country where the equipment is to be used, it must be returned to AR RF/Microwave Instrumentation. Warranty service will be provided only for defective goods which are returned within the warranty period, freight costs prepaid to AR RF/Microwave Instrumentation or its designated repair facility.

There are no other warranties, express or implied, including any warranty of merchantability or fitness. Seller shall not be responsible for any incidental or consequential damages arising from any breach of warranty.

No person other than an officer of Amplifier Research Corporation, has any authority to bind seller to any affirmation, representation or warranty except as specifically included in the preceding terms and conditions.

